

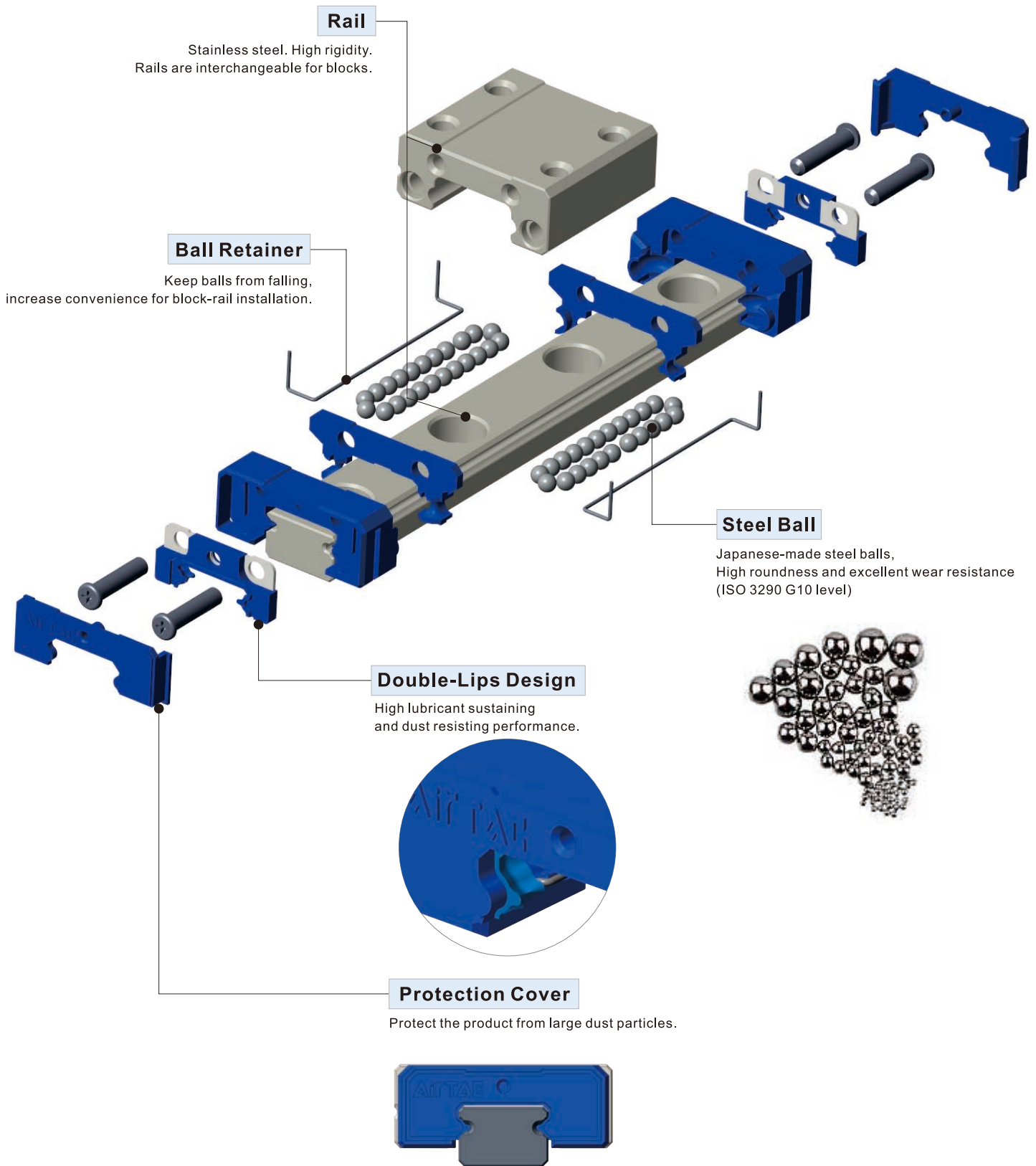

Product Introduction



LRM Series



Order Information(Combined)

LRM 7 N 1 X40 S5 A H T

① ② ③ ④ ⑤ ⑥ ⑦ ⑧ ⑨

① Model Code	LRM : Miniature Linear Guide				
② Rail Width	5 : 5mm	7 : 7mm	9 : 9mm	12 : 12mm	15 : 15mm
③ Block type	N: Standard L: Long				
④ Number of Block	1: One 2: Two [Note: Amount of block on a single set of linear guide]				
⑤ Rail Length	40: 40mm..... [Refer to rail spec. table for detail]				
⑥ Position of first mounting hole	S [□] : Distance from end of rail to the center of first mounting hole. (It is recommended to be greater than minimum edge) [Refer to rail spec table for details]				
⑦ Preload	A: Standard clearance B: Light Preload C: Medium Preload				
⑧ Accuracy	H : High P : Precision				
⑨ Rail type	Blank : Top-Mount T : Bottom-Mount				

Butt-jointed Order Information

LRM 7 N 1 X 705 T 705 A H T

① ② ③ ④ ⑤ ⑥ ⑦ ⑧ ⑨ ⑩

① Model Code	LRM : Miniature Linear Guide				
② Rail Width	5 : 5mm	7 : 7mm	9 : 9mm	12 : 12mm	15 : 15mm
③ Block type	N: Standard L: Long				
④ Number of Block	1: One 2: Two [Note: Amount of block on a single set of linear guide]				
⑤ Length of first Rail	705: 705mm[Defined by customer]				
⑥ Butt-jointed mark	T: Rail Butt-jointed mark(Butt-jointed end margin:1/2P) [P is the standard hole distance]				
⑦ Length of tail Rail	705: 705mm[Defined by customer]				
⑧ Preload	A: Standard clearance B: Light Preload C: Medium Preload				
⑨ Accuracy	H : High				
⑩ Rail type	Blank : Top-Mount T : Bottom-Mount				

Butt-jointed end margin:1/2P ,
Position of the first and last
hole is defined by customer.

[Note 1] Allow only two rails for standard joint. Customization is needed for more than two rails.
[Note 2] Customization is needed if the first/last mounting hole position is out of range in 'Rail Specification Table'.

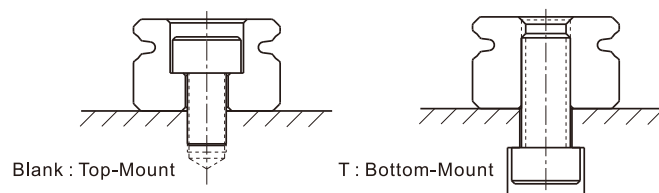

LRM Series

1. Block Order Information

LRM 7 BK - N - H - D

Notes: 1. When selecting rails and bearings, the different pairing codes can change the units preload, details see "preload pairing chart".
2. LRM5 block cannot be ordered individually.



① Model Code	LRM : Miniature Linear Guide
② Rail Width	7 : 7mm 9 : 9mm 12 : 12mm 15 : 15mm
③ Block Code	BK: Block
④ Block Type	N: Standard L: Long
⑤ Accuracy	H : High
⑥ Group Code	A B C D [Note]

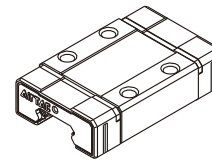

N: Standard

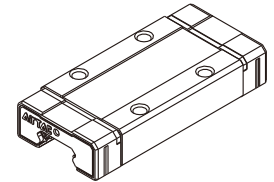

L: Long

2. Uncut Rail Order Information

LRM 7 RLX 985 - H - D - T

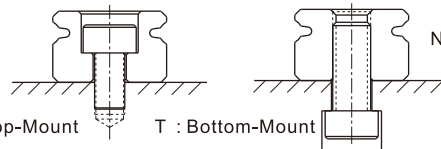

Blank : Top-Mount

T : Bottom-Mount

Note: 1. When selecting rails and bearings, the different pairing codes can change the units preload, details see "preload pairing chart".
2. LRM5 rail cannot be ordered individually.

① Model Code	LRM: Miniature Linear Guide
② Rail Width	7:7mm 9:9mm 12:12mm 15:15mm
③ Rail Code	RL: Rail
④ Rail Length	985:985mm 995:995mm 995:995mm 990:990mm
⑤ Accuracy	H : High
⑥ Group Code	D [Note]
⑦ Rail Type	Blank : Top-Mount T : Bottom-Mount

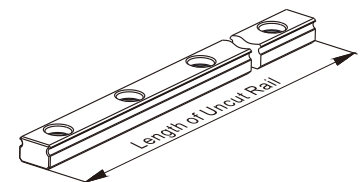

3. Rail Order Information

LRM 7 RLX40 - S5 - H - D - T



Note: 1. When selecting rails and bearings, the different pairing codes can change the units preload, details see "preload pairing chart".
2. LRM5 rail cannot be ordered individually.

① Model Code	LRM: Miniature Linear Guide
② Rail Width	7 : 7mm 9 : 9mm 12 : 12mm 15 : 15mm
③ Rail Code	RL: Rail
④ Rail Length	40: 40mm..... [Refer to rail spec. table for detail]
⑤ Position of first mounting hole	S□ : Distance from end of rail to the center of first mounting hole. (It is recommended to be greater than minimum edge) [Refer to rail spec table for details]
⑥ Accuracy	H : High
⑦ Group Code	D [Note]
⑧ Rail Type	Blank : Top-Mount T : Bottom-Mount

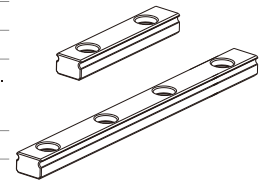

4. Accessory (Bolt hole plug) Order Code

L - BC - M3 - 10P



Note:

- Bolt hole plugs are packed in one bag per 10pcs. EX: When ordering 1pc of "L-BC-M3-10P", it comes with 10pcs plugs;
- "L-BC-M3-10P" is applied to LRM9/12/15 series;
- When mounting plugs for LRM9 series, short head bolts are required, bolt size is shown in the following figure.

① Accessories	L: Linear Guide Accessory
② Plug Code	BC: Bolt hole plug
③ Plug Specification	M3: Used for M3 bolt
④ Plug quantity	10P: 10pcs/bag

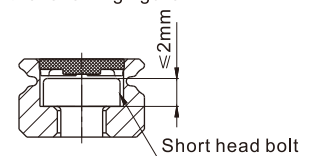

5. Rail/Block preload pairing chart

When customer orders rail/block, please choose the pairing code of rail/block in accordance with the needed preload of linear guide(combined). Details please refer to the "preload pairing chart".

Preload grade	Rail pairing code	
	D	
Block pairing code	B	Medium preload
	C	Light preload
	D	Standard clearance

Preload grade	Rail pairing code	
	D	
Block pairing code	A	Medium preload
	B	Light preload
	C	-
	D	Standard clearance

LRM Series

Rail Specification

The edge pitch of first mounting hole (S) and last mounting hole (E) should not be greater than 1/2P. Overlong edge may induce unstable installation and affect the accuracy.

n: Numbers of mounting holes

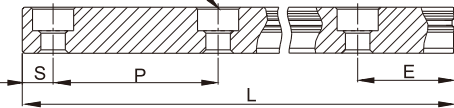

$$L = (n-1) \times P + S + E$$

L: Total length of rail (mm)

n: Numbers of mounting holes on rail

P: Distance between bolt holes (mm)

S: Edge of first mounting hole (mm)

E: Edge of last mounting hole (mm)

Model	Maximum length(L max)(mm)
LRM5	490
LRM7	985
LRM9	995
LRM12	995
LRM15	990

Model	Pitch(P)	Standard Edge pitch	Min. Edge Pitch (S/E min)	Max. Edge Pitch (S/E max)
LRM5	15	5	3	10
LRM7	15	5	3	10
LRM9	20	7.5	4	15
LRM12	25	10	4	20
LRM15	40	15	4	35

Note: • Joint rail must be chosen if length of rail exceeds the maximum.

• When deciding edge pitch, it should be within the range of above table. There would be risk of broken hole if pitch is out of range.

Specifications and Dimensions

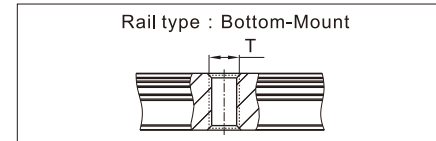
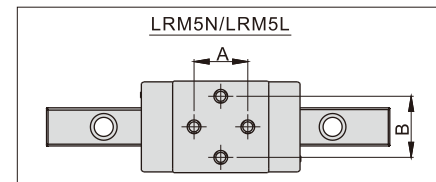
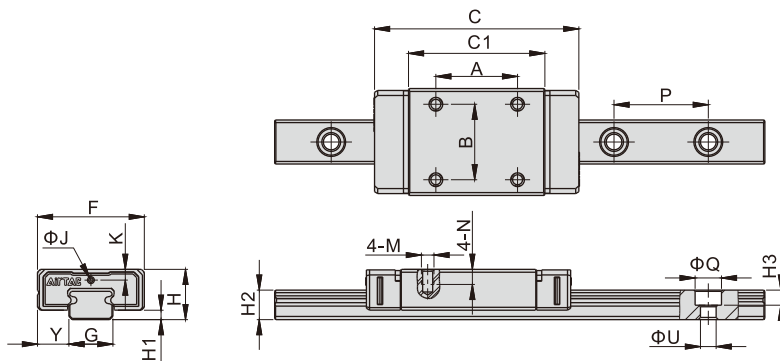

Model/Item	External Dimension (mm)					Block Dimension (mm)							Rail Dimension (mm)						
	H	H1	F	Y	C	C1	A	B	M	N	K	ΦJ	G	H2	P	ΦQ	ΦU	H3	T
LRM5N	6	1.5	12	3.5	18.2	10	7	8	M2X0.4	1.5	1.3	0.7	5	3.5	15	3.5	2.2	1.1	M3X0.5
LRM5L	6	1.5	12	3.5	21.2	13	7	8	M2X0.4	1.5	1.3	0.7	5	3.5	15	3.5	2.2	1.1	M3X0.5
LRM7N	8	1.5	17	5	24.3	13.5	8	12	M2X0.4	2.3	1.7	0.7	7	4.7	15	4.2	2.4	2.4	M3X0.5
LRM7L	8	1.5	17	5	32.5	21.7	13	12	M2X0.4	2.3	1.7	0.7	7	4.7	15	4.2	2.4	2.4	M3X0.5
LRM9N	10	2	20	5.5	31	18.9	10	15	M3X0.5	2.8	2.2	1	9	5.6	20	6	3.5	3.4	M4X0.7
LRM9L	10	2	20	5.5	42.1	30	16	15	M3X0.5	2.8	2.2	1	9	5.6	20	6	3.5	3.4	M4X0.7
LRM12N	13	3	27	7.5	37.6	21.7	15	20	M3X0.5	4	3	1.5	12	7.5	25	6	3.5	4.4	M4X0.7
LRM12L	13	3	27	7.5	48.4	32.5	20	20	M3X0.5	4	3	1.5	12	7.5	25	6	3.5	4.4	M4X0.7
LRM15N	16	3.5	32	8.5	48	28	20	25	M3X0.5	4	3.7	M3	15	9.5	40	6	3.5	4.4	M4X0.7
LRM15L	16	3.5	32	8.5	65	45	25	25	M3X0.5	4	3.7	M3	15	9.5	40	6	3.5	4.4	M4X0.7

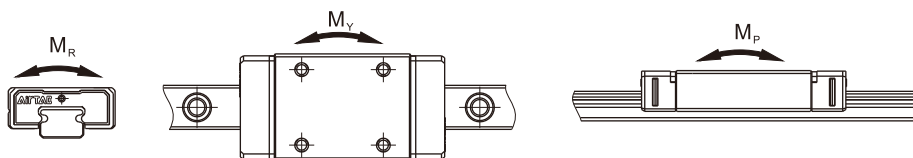

Model/Item	Mounting Screw	Dynamic Load Rating (kN)		Static Load Rating (kN)		Static Rated Moment (N.m)			Weight	
		C _{100B}	C ₀	C ₀	C ₀	M _R	M _P	M _Y	Block(kg)	Rail(kg/m)
LRM5N	M2	0.33	0.55	1.68	0.99	0.99	0.0035	0.114		
LRM5L	M2	0.48	0.9	2.4	2.08	2.08	0.004	0.114		
LRM7N	M2	1.02	1.53	5.42	3.17	3.17	0.009	0.22		
LRM7L	M2	1.43	2.45	9.27	7.96	7.96	0.014	0.22		
LRM9N	M3	1.97	2.6	11.84	8.19	8.19	0.018	0.315		
LRM9L	M3	2.61	4.11	19.73	18.94	18.94	0.027	0.315		
LRM12N	M3	3.04	3.86	23.63	12.57	12.57	0.037	0.602		
LRM12L	M3	3.96	5.9	40.96	32.57	32.57	0.053	0.602		
LRM15N	M3	4.27	5.7	45.05	23.05	23.05	0.054	0.981		
LRM15L	M3	6.53	9.53	70.08	63.69	63.69	0.088	0.981		

Accuracy

LRM miniature linear guide comes with 2 accuracy levels.

Accuracy Standards (mm)	Accuracy Standards (mm)	
	H: High	P: Precision
Tolerance of height H	±0.02	±0.01
Variation of height ΔH	0.015	0.007
Tolerance of width Y	±0.025	±0.015
Variation of width ΔY	0.02	0.01

Parallelism of motion relative to benchmark surface.

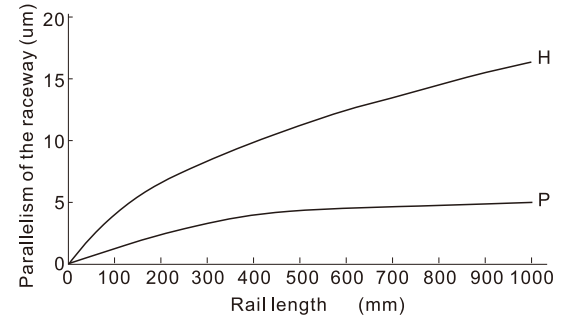

Preload Level

LRM Miniature Linear Guide has three preload categories: A, B and C.

Choosing suitable preload level will enhance rigidity, precision and torsion resistant performance of the linear guide.

Preload Level	Code	Radial interference (μm)					Application
		5	7	9	12	15	
Standard clearance	A	-1~+2	-2~+2	-2~+2	-2~+3	-2~+3	Smooth operation
Light Preload	B	-3~-1	-4~-2	-5~-2	-6~-2	-7~-2	High Precision
Medium Preload	C	-6~-2	-7~-3	-8~-4	-9~-5	-10~-6	High rigidity

Load Capacity and Rating Life

1. Basic static load rating (C₀)

It is defined as the static load when the total permanent deformation of the steel ball and the surface of the groove is exactly one ten-thousandth of the diameter of the steel ball under the state of the load direction and size unchanged.

2. Static Permissible Moment (M₀)

When the steel ball subjected to the maximum stress in the slider reaches a static rated load condition, this loading moment is called the "Static permissible moment". The definition comes in three directions.

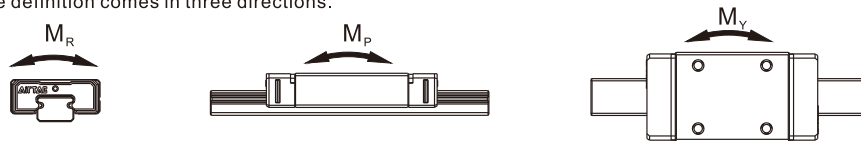

3. Static Safety Factor (f_s)

Impact, vibration and inertial loading during start and stop moment lead to unexpected load on the linear guide way. Therefore, when calculating the static load, safety factors must be considered.

Load Condition	f _s
Normal Load	1.0~2.0
Load with Impacts or Vibrations	2.0~3.0

$$f_s = \frac{C_0}{P} = \frac{M_0}{M}$$

f_s : Static safety factor

C₀ : Basic static load rating (N)

M₀ : Static permissible moment (N.m)

P : Calculated working load (N)

M : Calculated applying moment (N.m)

4. Load Factor (f_w)

The loads acting on a linear guide way include the weight of block, the inertia load at the times of start and stop, and the moment loads caused by overhanging. Therefore, the load on a linear guide way should be divided by the empirical factor.

Loading condition	Service speed	f _w
No impacts & vibration	V ≤ 15m/min	1~1.2
Small impacts	15m/min < V ≤ 60m/min	1.2~1.5
Normal load	60m/min < V ≤ 120m/min	1.5~2.0
With impacts & vibration	V > 120m/min	2.0~3.5

5. Dynamic Load Rating (C_{100B})

C_{100B} : (According to ISO 14728-1) As the direction and magnitude remains the same, C_{100B} is the maximum workload for the product to maintain its nominal life at 100km of operation.

LRM Series

6. Calculation of Nominal Life(L)

Recognizing that nominal life of a linear guide is affected by the actual working loads, the general calculation of the nominal life excluding the environmental factors is carried out as follow: :

$$L = \left(\frac{C_{1000}}{f_w \times P} \right)^3 \times 10^5$$

L = Nominal Life (m)

C₁₀₀₀ = Dynamic Load Rating (N)

f_w: Load Factor

P = Equivalent load (N)

Taking LRM9N for example, its C₁₀₀₀ is 1.97kN. Therefore, when the product bears a 1.5kN equivalent load P, f_w=1, its theoretical rated life can be calculated as follows:

$$L = \left(\frac{C_{1000}}{f_w \times P} \right)^3 \times 10^5 = \left(\frac{1.97}{1 \times 1.5} \right)^3 \times 10^5 = 226529 \text{ m} = 226.5 \text{ km}$$

Installation Illustration

1. Height and Chamfer of Reference Edge

In order to ensure accurate installation of LRM Linear Guide, the contact space should not exceed the given figures in following table.

Unit : mm

Model	Q1	Q2	H1	R(Max)
LRM5	2	1.2	1.5	0.2
LRM7	3	1.2	1.5	0.2
LRM9	3	1.7	2	0.3
LRM12	4	2.7	3	0.4
LRM15	5	3.2	3.5	0.5

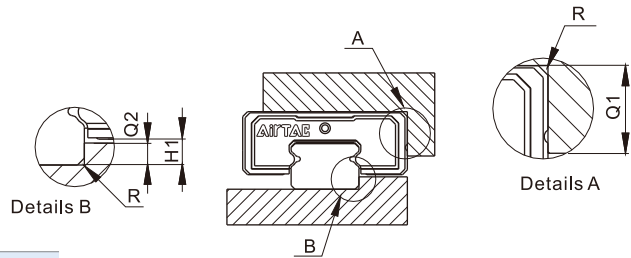

2. Screw Tighten Torque

Model	Screw size	Tighten Torque(N.cm)		
		Iron	Casting	Aluminum alloy
LRM5	M2	58.8	39.2	29.4
LRM7				
LRM9	M3	196	127	98
LRM12				
LRM15				

3. Datum plane

- Datum plane for installation must be ground or finely milled to ensure accuracy.
- Both sides of rail can be used as the datum plane.
- For multi-blocks on a rail, identification line on blocks should be put on the same side to ensure moving accuracy.

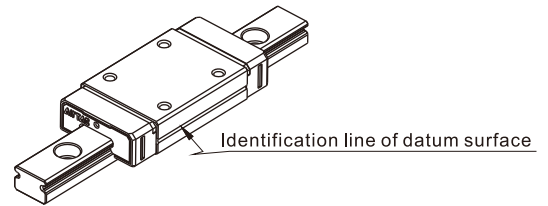

Rail Butt-jointed

- When jointing rails, it must follow group marks on rail to ensure the accuracy of linear guide. These marks are located on the top surface at joint side. Please put the same group marks together.

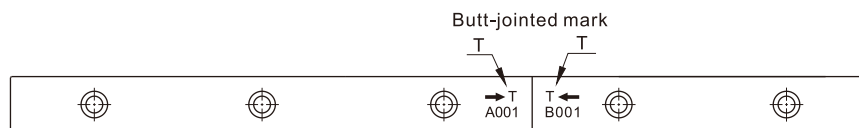

- Be aware serial number of group mark when assemble. A001 and B001 are in a group, so as to A002 and B002 and so on.
- Be aware the installation direction while assembly, the serial numbers are not upside down and arrows point to each other.

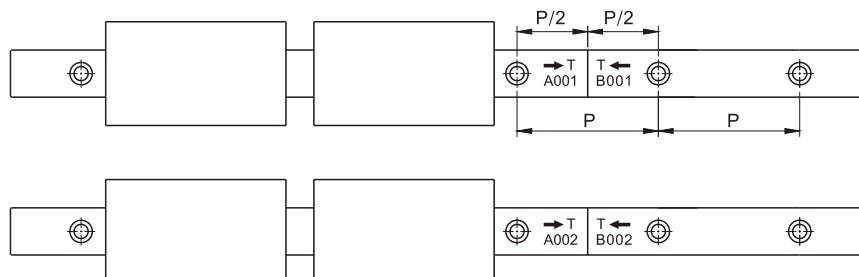

LRM Series

Lubrication Method

When a linear guide is well lubricated, it can reduce wear and increase lifespan significantly. Lubrication has the following benefits:

- Reduces friction of the rollers and rail to minimize wear.
- The grease film between contact surface can decrease the fatigue failure.
- Prevent rust.

1. Lubrication method

LRM series linear guide is well lubricated with 'Synergy Grease PS NO.2' in factory.

Customers are recommended to use identical or the same grade of lubricant.

Please refer to the right table for the amount of oil:

In order to be well lubricated, the blocks need to be moved back and forth after lubricating.

Lubrication can be done either by manual or automatic device.

Model	Initial lubrication (cm ³)	Replenishment amount (cm ³)
LRM5N	0.02	0.01
LRM5L	0.03	0.015
LRM7N	0.1	0.05
LRM7L	0.13	0.07
LRM9N	0.2	0.1
LRM9L	0.28	0.14
LRM12N	0.34	0.17
LRM12L	0.45	0.23
LRM15N	0.72	0.36
LRM15L	1.0	0.50

2. Lubrication frequency

Although the linear guides are well lubricated at the factory and retains grease well, frequent lubrication is still necessary to avoid undesirable wear.

Recommended lubrication period is every 100km of movement or every 3~6 months. (Refer to table on the right for suggested amount).

Precautions on use

1. Block disassembly

LRM is equipped with ball retainers to prevent steel balls from falling out when block separates from rail. However, if obliquely insert rail into blocks or quickly assemble and disassemble, there is risk for steel balls of falling out. Please carefully assemble the linear guide or use plastic rails to assist.

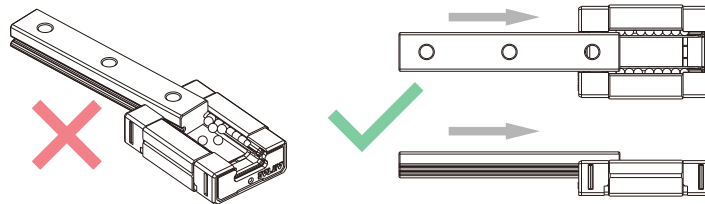

2. Caution

- Parts may slide out if linear guide is put unevenly. Please be careful.
- Hitting or dropping a linear guide could have huge effects on accuracy and lifespan even though appearance may remain intact. Please be careful.
- Do not separate linear guide as external objects may enter blocks and cause accuracy problem.

3. Lubrication

- Linear guide have been treated with anti-rust oil during production. Before use, wipe the rail and treat it with lubrication.
- Do not mix lubricating oil (grease) with different properties.
- While lubricating, the block needs to be moved back and forth. After lubrication, there should be a grease film on rail.

4. Use

- The operating environment temperature should not exceed 80°C, and the maximum temperature should not exceed 100°C.
- Do not separate blocks from rail whenever it is not necessary. If you need to separate them, please use plastic rails to prevent steel balls from falling out.

5. Storage

- When storing blocks, rails or set, please be sure that anti-rust oil is well applied and product is well sealed as well as placed horizontally. Avoid humidity and high temperatures environment.