

Speed Controller with Dial Adjuster and Push Lock

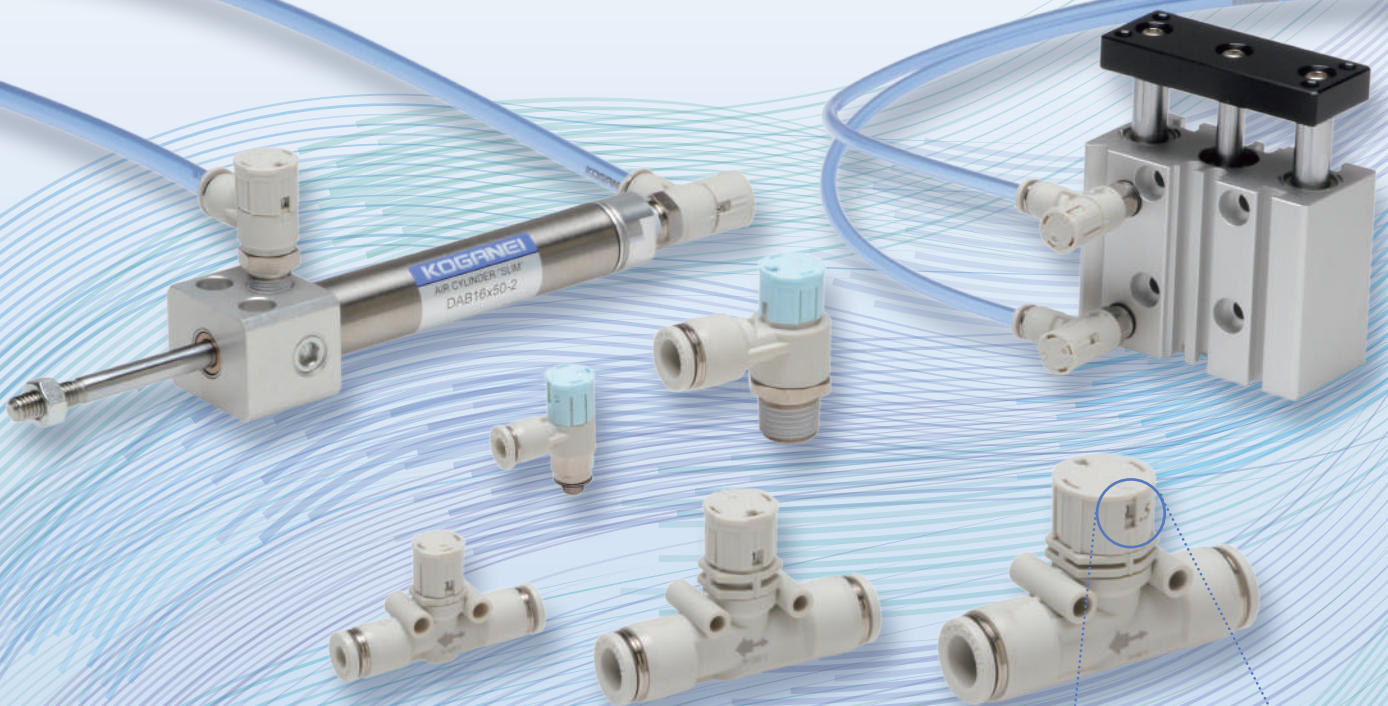

**Reduce man-hours spent on
flow settings!**

- Adjustable at every half rotation
- Easy to adjust linear flow characteristics
- Smallest in the industry, designed with low profile.



**Flow settings are
visualized!**

Speed Controller with Dial Adjuster and Push Lock



Symbol

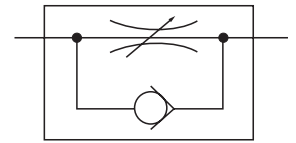

Features

Flow rate can be confirmed by the indicator. Indicators are located in 2 areas, side (upper/lower) and top. (*)



Side dial lower window
(Rotation count: 1, 2, 3...)



Side dial upper window
(Rotation count: 0.5, 1.5, 2.5...)



Top dial
(Displays for each single rotation)



*) Dial indicator on union straight can be adjusted to face 360°.

*) Top dial is not available on the metric thread type of elbow or union straight $\phi 4$ mm [0.157 in.].

Rotation count and flow rate increase/decrease with proportional linear characteristics. Low flow rate types with micro-adjustments are available. (*)

See page 8 for flow characteristics.

*) Note: Koganei's low speed control type speed controller has different flow rate ranges.

Example: Flow characteristics SCDC8-02□ (controlled flow)

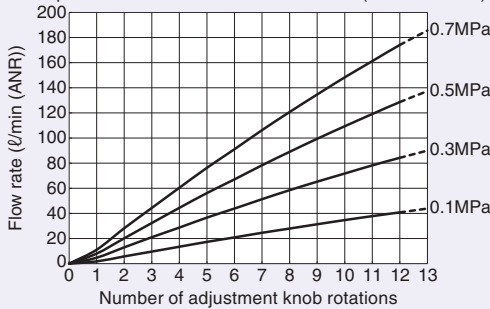

Compact design.

World's smallest speed controller with dial.

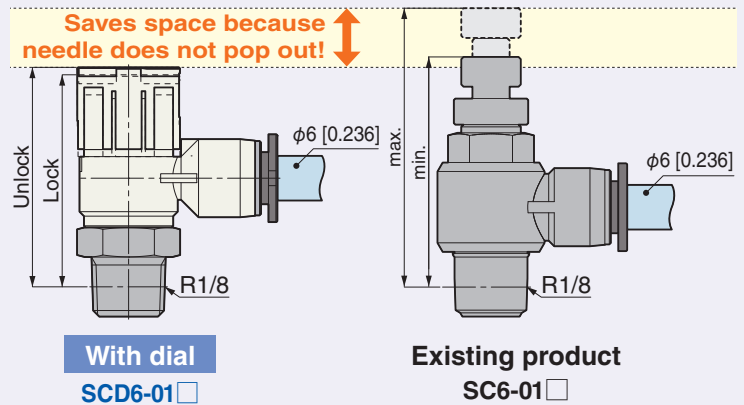

With push lock knob.
Easy one-handed settings and operations.

The position is lockable in 30 levels within 1 rotation.
(The position where the dial can be confirmed is every 0.5 rotations.)



Color of knob identifies control direction.

Meter-out control

Connects directly to double-acting cylinder for speed control.



Meter-in control

Connects directly to single-acting cylinder for speed control.



Rubber material of the diaphragm is HNBR.



Internal Configuration and Materials of Major Parts

● For elbow (SCD□□)

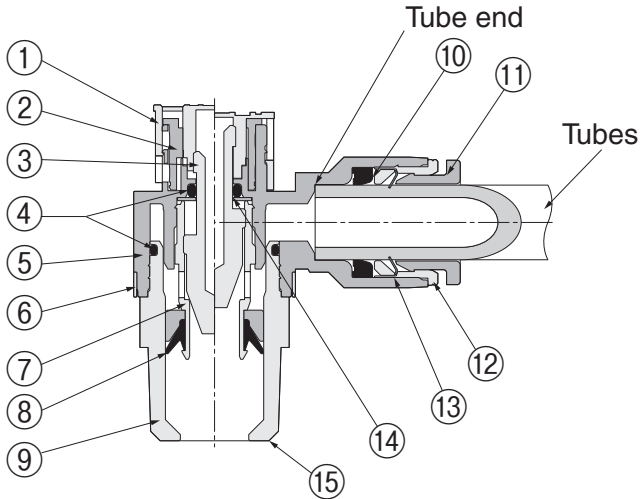

No.	Name	Material
①	Knob	POM
②	Dial	PBT
③	Needle	Brass
④	O-ring	NBR
⑤	Plastic body	PBT
⑥	Ring ^{Note 1}	Brass, electroless nickel plated
⑦	Metal body	Brass, electroless nickel plated
⑧	Diaphragm	HNBR
⑨	Threaded body	Brass, electroless nickel plated ^{Note 2}
⑩	Elastic sleeve	NBR
⑪	Release ring	POM
⑫	Guide ring	Brass, electroless nickel plated
⑬	Lock hook	Stainless steel
⑭	Collar ^{Note 1}	POM
⑮	Tapered threads for pipes: Sealock processing	—
	Metric threads: With gasket	SUS304+NBR

Note 1: 04 thread size (R1/2) only.

2: For M3 thread size: Special stainless steel.

● For union straight (SSUD□□)

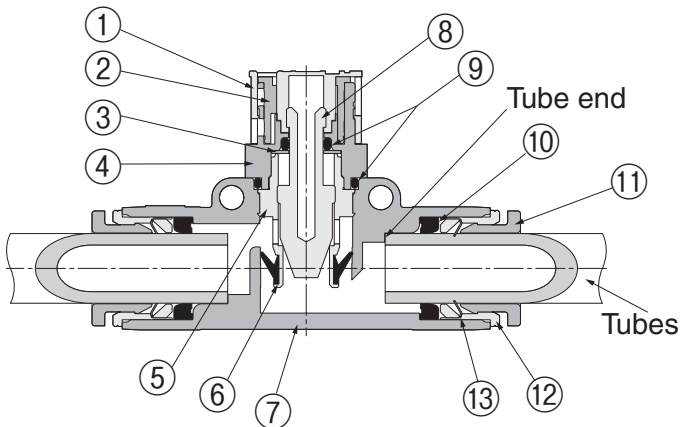

No.	Name	Material
①	Knob	POM
②	Dial	PBT
③	Collar ^{Note}	POM
④	Dial cover	PBT
⑤	Metal body	Brass, electroless nickel plated
⑥	Diaphragm	HNBR
⑦	Plastic body	PBT
⑧	Needle	Brass
⑨	O-ring	NBR
⑩	Elastic sleeve	NBR
⑪	Release ring	POM
⑫	Guide ring	Brass, electroless nickel plated
⑬	Lock hook	Stainless steel

Note: Tube size 12 ($\phi 12$ [0.472]) only

Specifications

Item	Model	SCD□□□□	SSUD□□
		Elbow type with dial	Union straight type with dial
Medium		Air (Cannot be used for vacuum)	
Operating pressure range		0.1 to 1.0 MPa [15 to 145 psi]	
Reverse valve working pressure		0.05 MPa [7 psi]	
Operating temperature range		0 to 60°C [32 to 140°F] (non-freezing)	
Recommended tubes		Nylon or urethane tubes	
Sales unit		1 pc.	

Control direction and identification

● Control direction

Code	A	B
Control direction	<p>Meter-out control</p> <p>Controls air entering from threaded side, does not control air entering from fitting side, which is output from threaded side.</p>	<p>Meter-in control</p> <p>Controls air entering from fitting side, does not control air entering from threaded side, which is output from fitting side.</p>
Identification method	Knob color: Light gray	Knob color: Light blue

Order codes

● Elbow type with dial

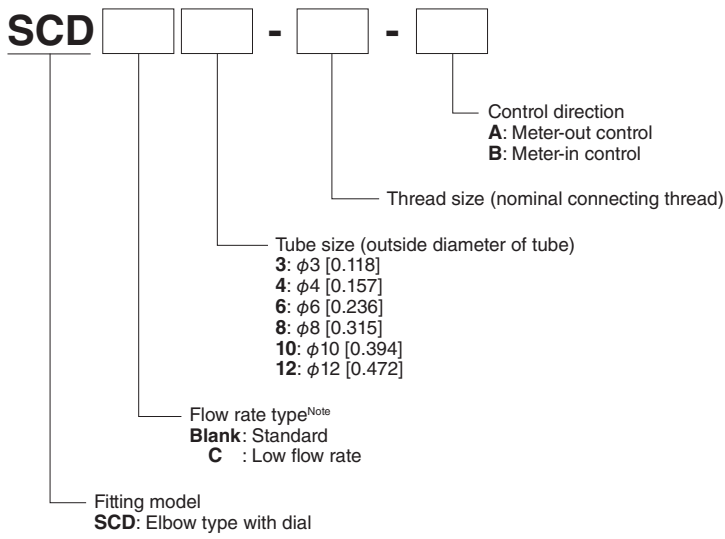

● Union straight type with dial

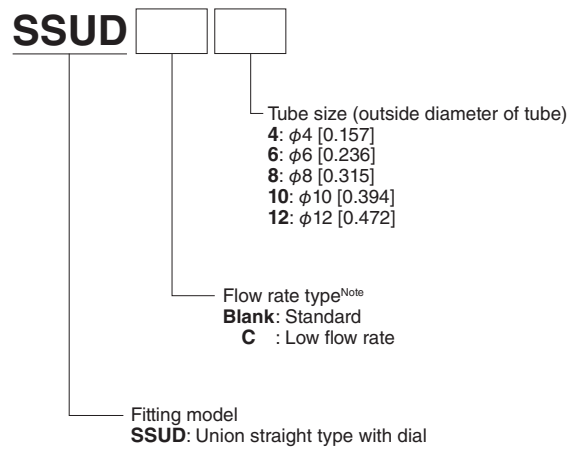

Note: How to identify flow rate types

Standard

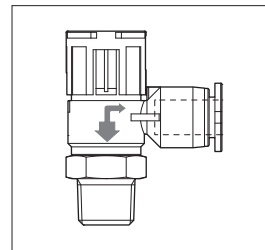

Low flow rate (C is engraved on exterior)

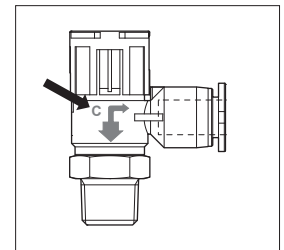





Remarks: Above diagram is for elbows, but union straights are the same.

Tube size	Screw size					
	M3×0.5	M5×0.8	R1/8	R1/4	R3/8	R1/2
3	M3	M5	-	-	-	-
4	M3	M5	01	-	-	-
6	-	M5	01	02	03	-
8	-	-	01	02	03	04
10	-	-	-	02	03	04
12	-	-	-	-	03	04

Safety precautions (speed controllers with quick fittings) Before use, be sure to read the safety precautions.

Before selecting and using an appropriate product, please read all the safety precautions carefully to ensure proper product use. The safety precautions described below are intended to help you use the product safely and correctly and to prevent injury to you or other people and damage to property. Always adhere to ISO4414 (Pneumatic fluid power - General rules and safety requirements for systems and their components), JIS B 8370 (Pneumatic fluid power - General rules relating to systems), and other safety regulations.

The directions are classified according to the degree of potential danger or damage as **DANGER, WARNING, CAUTION, and ATTENTION.**

 DANGER	Indicates situations that can be clearly predicted as dangerous. Death or serious injury may result if the situation is not avoided. It could also result in damage or destruction of assets.
 WARNING	Indicates situations that, while not immediately dangerous, could become dangerous. Death or serious injury may result if the situation is not avoided. It could also result in damage or destruction of assets.
 CAUTION	Indicates situations that, while not immediately dangerous, could become dangerous. Minor or semi-serious injury may result if the situation is not avoided. It could also result in damage or destruction of assets.
 ATTENTION	Indicates no risk of injury, but gives points that should be observed for proper use of the product.

■ This product was designed and manufactured as a part for use in general industrial machinery.

- When selecting and handling equipment, the system designer or another person with sufficient knowledge and experience should always read the safety precautions, catalog, instruction manual and other literature before commencing operation. Improper handling is dangerous.
- After reading the "Owner's Manual", catalog, and other documentation, store them in a location where they are easily available for reference by users of this product.
- Whenever transferring or lending the product to another person, always attach the instruction manual, and other information to the product where they are easily visible in order to ensure that the new user can use the product safely and properly.
- The danger, warning and caution items listed in these safety precautions do not cover all possible contingencies. Read the catalog and instruction manual carefully, and always keep safety first.

 **DANGER**

- Do not use the product for the purposes listed below:
 1. Medical equipment related to maintenance or management of human life or health
 2. Machines or equipment designed for the purpose of moving or transporting people
 3. Critical safety components in mechanical devices
 This product has not been planned or designed for purposes that require high levels of safety. Using the product in any of the ways described above creates the risk of loss of human life.
- Do not use the product in locations with dangerous substances such as flammable or ignitable substances. This product is not explosion-proof. There is a risk of ignition and fire.
- When mounting the product, always make sure it is firmly supported and secured (including the workpiece). If the product tips over, drops, or malfunctions, there is a risk of personal injury.
- Never modify the product. Abnormal operation can lead to injury.
- Never inappropriately disassemble/assemble or repair the basic structure, performance, or functions of the product. Doing so may cause injury.
- Do not splash water on the product. Splashing water on the product, washing the product, or using the product under water may cause abnormal operation leading to injury, etc.
- While the product is operating, avoid touching it with your hands or otherwise approaching too close. Also, do not attempt to make any adjustments to internal or attached mechanisms, or to perform any type of adjustment (releasing a lock, disconnecting tubes or sealed plugs, adjusting the installation position of the product, etc.) while the product is operating. If the product drops, malfunctions, or sprays medium, there is a risk of personal injury.

 **WARNING**

- Koganei products can be used under a variety of conditions. Therefore, the person responsible for system design must fully evaluate the products to determine compatibility with the system. The designer who determines the suitability of the system is responsible for guarantying the desired performance and safety of the system. Safe and reliable system configuration (e.g., fail-safe) is required considering the possibility of equipment failure through adequate verification and evaluation of the specifications based on the latest catalog and other technical documents.
- Do not use the product in excess of its specification range. Using the product outside its specified range causes it to malfunction, stop functioning, and break. Also, significantly reduced service life results.
- Before supplying air to the product and before starting operation, be sure to confirm that the operating range of the device is safe. Unintentional supply of air creates the risk of injury due to contact with moving parts.
- Do not allow the product to be thrown into fire. Doing so creates the risk of the product exploding or the release of toxic gases.
- Do not sit, stand, or place objects on the product. Doing so creates the risk of injury due to tripping or the product tipping over or falling, resulting in product damage and abnormal, erratic, or runaway operation.
- Before various types of work on the product, such as maintenance inspections, repairs, or parts replacement, be sure to completely disconnect the air supply, and confirm that pressure inside the product and piping connected to the product is zero. In particular, be aware that pressure remains in the compressor and air tank. The actuator may move abruptly if residual air pressure remains inside the piping, causing injury.
- Design equipment, as well as safety circuits, so that people are not injured and equipment is not damaged if there is an emergency stop, power outage, or other system abnormality that stops the machinery.
- Always check the catalog and other reference materials for correct product piping. Improper piping creates the risk of abnormal operation of the actuator.

Safety precautions (speed controllers with quick fittings)

- Do not use the product near the ocean, in direct sunlight, near mercury vapor lamps, or near equipment that generates ozone. Deterioration of rubber parts caused by ozone may reduce performance and functions, or stop functions. (except for ozone-resistant products)
- Do not use media other than the ones listed in the specification table. Using a medium not listed in the specification table could lead to a short-term stoppage of functions, sudden degradation in performance, or reduced operating life.
- Do not use the product in the vicinity of heat sources or radiated heat.
- Always lock the adjustment knob before starting normal operations.
Erratic operation could result.
- Do not use the product in locations subject to direct sunlight (ultraviolet radiation); in locations subjected to high temperature or humidity; in locations where dust, salt, or iron particles are present; or in locations with media and/or an ambient atmosphere that includes organic solvents, phosphate ester type hydraulic oil, sulfur dioxide gas, chlorine gas, acids, etc. It could lead to early shutdown of some functions, a sudden degradation of performance, and a reduced operating life. For information about materials, refer to "Materials of Major Parts."



CAUTION

- When mounting the product, leave room for adequate working space around it. Failure to leave working space will make it more difficult to conduct daily inspections or maintenance, which could eventually lead to system shutdown or damage to the product.
- Do not deform, scratch, or mar the main unit by sitting, standing or placing objects on the product. Doing so could result in operations stopping or performance falling due to the product being damaged or broken.
- When doing installation or adjustment work, clearly display work-in-progress signs so that the air supply is not turned on unintentionally. Unintentional supply of air creates the risk of injury due to sudden operation.
- Pneumatic equipment is not completely air-leak-free. Designs should take into consideration the capacity and retention time required for pressure retention within the pressure vessel, etc.
A reduction in retention force can lead to workpieces falling, position deviation, damage to equipment, and injury.



ATTENTION

- Whenever considering use of this product in situations or environments not specifically noted in the catalog or in manuals, or in applications where safety is an important requirement such as in aircraft facilities, combustion equipment, leisure equipment, safety equipment, and other places where human life or assets may be greatly affected, take adequate safety precautions such as allowing plenty of margin for ratings and performance, and fail-safe measures. Contact Koganei regarding use in such applications.
- Wear protective gloves, safety glasses, safety shoes, and other protective clothing as necessary to be safe when handling the product.
- When the product can no longer be used or is no longer necessary, dispose of it appropriately as industrial waste.
- Pneumatic equipment can exhibit degraded performance and functions over its operating life. Always conduct daily inspections on pneumatic equipment and confirm that all requisite system functions are satisfied to prevent accidents from happening.
- For inquiries about the product, consult your nearest Koganei sales office or the Overseas Department. The addresses and telephone numbers are shown on the back cover of this catalog.



Other precautions

- Always observe the following items.
 1. When using this product in a pneumatic system, use only genuine Koganei parts or compatible parts (recommended parts).
Use only genuine Koganei parts or compatible parts (recommended parts) to do maintenance or repairs.
Use only specified procedures and methods.
 2. Never inappropriately disassemble or modify the product in relation to its basic construction, performance, or functions.

Koganei bears no responsibility if these safety precautions are not fully observed.

Warranty and disclaimer

1. Warranty Period
The warranty period of Koganei products is one year from the date of delivery.
* Some products have a two-year warranty period. For details, contact the nearest Koganei sales office or Overseas Department.
2. Warranty scope and disclaimer
 - (1) If a failure attributable to Koganei is found in a product purchased from Koganei or an authorized retailer/dealer during the warranty period, Koganei will repair or replace it free of charge. For some products, a service life, such as the number of operations, may be specified in their warranty periods. For details, contact the nearest Koganei sales office or the Overseas Department.
 - (2) The Koganei product warranty covers that product alone. Consequently, Koganei is not responsible for any incidental damage (including costs incurred for the repair and replacement of the product) attributable to any failure of the Koganei product, decrease in function, or decrease in performance.
 - (3) Koganei is not responsible for any losses or for any damages to other machinery caused by breakdown, loss of function, or loss of performance of Koganei products.
 - (4) Koganei is not responsible for any losses due to use or storage of the product in a way that is outside of the product specifications prescribed in Koganei catalogs and instruction manuals, and/or due to actions that violate the mounting, installation, adjustment, maintenance or other safety precautions.
 - (5) Koganei is not responsible for any losses caused by breakdown of the product due to factors outside the responsibility of Koganei, including but not limited to fire, natural disaster, the actions of third parties, and intentional actions or errors by the purchaser.

Safety Precautions (types with speed controller dial and quick fitting)

WARNING

- Some products have control directions for the air, so check this text and the identifiers on the main unit before using them. There is a risk of causing personal injury or damage to the device if the control direction is mistaken.
- 1. To adjust the speed of an actuator, start with the needle almost closed and then gradually open it. The actuator may move abruptly as the needle is opened. Note that turning the adjustment knob clockwise closes the needle, and turning it counterclockwise opens it.
- 2. Do not adjust the fitting position on an elbow while the inside of the product is pressurized. Doing so could result in leaks or damage to the main unit.
- 3. Do not adjust the orientation of the dial indicator on a union straight while the inside of the product is pressurized. Doing so could result in leaks or damage to the main unit.

CAUTION

1. Do not use the product if zero leakage is required because it has an allowance for leaks of the controlled flow when the needle is closed.
2. The flow characteristics are reference values for the product and vary due to the piping, circuit, and pressure conditions, etc. Ultimately, the speed should be checked for each product, because it depends on the individual variability of the product, the actuator, and the operating conditions such as temperature.
3. The adjustment knob locks when pushed and releases when pulled. Sometimes the lock cannot be released when the sides (at 90° to window) of the adjustment knob are strongly pinched.
4. After adjusting the flow rate, always lock it. If not locked, the adjustment knob could rotate and change the flow rate while the product is being used.
5. The adjustment knob may stop at an intermediate point, between locked and unlocked, when pushed, depending on the rotational position. In this state, the adjustment knob is not completely locked, so confirm that it is pressed all the way to the locked position.
6. Do not forcibly rotate the adjustment knob while it is locked. Doing so could damage the lock mechanism.
7. Do not rotate the adjustment knob excessively counterclockwise when it is fully open nor clockwise when it is fully closed. Doing so could cause damage to the adjustment knob or main unit.
8. The control ranges vary for each size. When adjusting the flow rate, check the value currently on the dial indicator, and then adjust it to within the control ranges shown in table 1. The dial indicator may not always be at "0" when the needle is fully closed.

Table 1. Control range

Elbow	Screw size	Metric threads (mm [in.])		Tapered threads for pipes			
		M3x0.5	M5x0.8	R1/8	R1/4	R3/8	R1/2
	Dial indicator value	0 - 8		0 - 12			

Union straight	Fitting size	Tube exterior diameter (mm [in.])					
		φ3 [0.118]	φ4 [0.157]	φ6 [0.236]	φ8 [0.315]	φ10 [0.394]	φ12 [0.472]
	Dial indicator value	0 - 8		0 - 12			

9. Be sure to hold a wrench securely on the flat sides of the union straight when adjusting the direction of the dial indicator. There is a possibility of deformation or interference with the adjustment knob.

Handling instructions and precautions

● Installation

Precautions for installing the main unit

- ① Use an appropriate tool on the hexagonal exterior of the main unit to tighten it.
- ② When installing a threaded part, tighten it to the recommended torque in the following table. Tightening it more than the tightening torque could damage the threads or deform the gasket, and cause leaks. Also, tightening it less than the recommended tightening torque could cause the threads to be loose and leak.

Recommended tightening torque

Screw type	Screw size	Tightening torque
Metric threads (mm [in.])	M3×0.5	0.7 N·m [6.196 in·lbf]
	M5×0.8	1 to 1.5 N·m [8.851 to 13.277 in·lbf]
Tapered threads for pipes	R1/8	4.5 to 6.5 N·m [39.830 to 57.532 in·lbf]
	R1/4	7 to 9 N·m [61.957 to 79.659 in·lbf]
	R3/8	12.5 to 14.5 N·m [110.6 to 128.3 in·lbf]
	R1/2	20 to 22 N·m [177.0 to 194.7 in·lbf]

Precautions for removing the main unit

- ① Use an appropriate tool on the hexagonal exterior of the main unit to remove it.
- ② Remove the sealant stuck to the threads on the other parts after removal. Sealant that is stuck to the parts could get into peripheral equipment and cause damage.

Tightening threaded parts

- ① Tightening threaded parts
Use a wrench on the hexagonal exterior to tighten the threaded part.

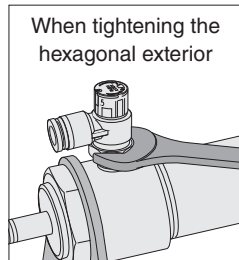

1. The sealant on the quick fittings can be reused multiple times, as is. However, the sealant may stick to the threaded parts of other devices. Be sure to clean the inside of the female threads on the devices.
2. When installing tubing, hold the tightening tool horizontally in relation to the hexagonal faces of the main unit. If you allow it to touch the plastic part of the main unit, as shown in the figure, you could damage the main unit.

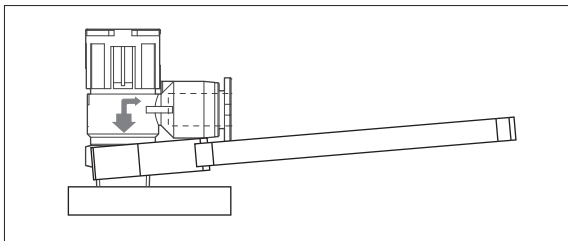

● Connecting/disconnecting tubes

Precautions for attaching tubes

- ① Confirm that the cut ends of the tubes are cut at right angles, that the outsides of the tubes are not scratched, and that the tubes are not oval.
- ② When attaching tubes, if they are not inserted all the way to their ends, they could leak.

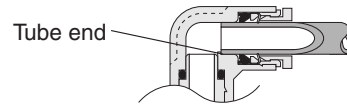

- ③ After attaching the tube, pull on it to confirm it does not come out.
- ④ Do not pointlessly press on the release ring before attaching a tube. Doing so could cause the tube to come out.

Precautions for removing tubes

- ① Confirm that the pressure inside the tubes is zero before removing tubes.
- ② Push the release ring evenly to the back and then pull out the tube toward you. If you do not push enough, the tube may not come out or chips scraped from the tube could be left inside the fitting.

How to connect/disconnect tubes

① Connecting tubes

For speed controllers with quick fittings, just insert the tube to its end so the flexible sleeve seals around the outside of the tube.

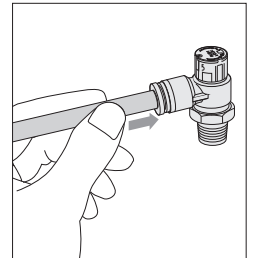

② Removing tubes

When removing a tube, pressing the release ring opens the lock claw so the tube can be released. Be sure to turn off the air before removing tubes.

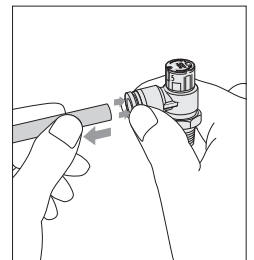

Handling instructions and precautions

If removing pipes is difficult because the piping space is constricted, consult your nearest Koganei sales office for a specialized tool that is available.

Specialized tool for removing tubes

For $\phi 3$ [0.118], $\phi 4$ [0.157], and $\phi 6$ [0.236] tubes
Order code: **UJ-1**



For $\phi 6$ [0.236], $\phi 8$ [0.315], $\phi 10$ [0.394], and $\phi 12$ [0.472] tubes
Order code: **UJ-2**



● Usable tubes

Either nylon or urethane tubes can be used. Use tubes that have the following exterior diameter accuracy: Nylon tubes nominal dimensions within ± 0.1 mm [0.004 in.], urethane tubes nominal dimensions within ± 0.15 mm [0.006 in.], and ovalness (difference of long and short diameters) within 0.2 mm [0.008 in.]. (We recommend using Koganei tubes.) Note that if you use tubes other than Koganei genuine tubes or compatible tubes (recommended tubes), problems could occur, such as tubes detaching or air leaking, so be sure to check the compressed air system before assembling it.



1. Use tubes that have no scratches on their outer surfaces. If they become scratched due to repeated use, replace those parts.
2. Do not allow tubing to become severely bent or twisted near the fitting. Doing so could cause air leakage. The following table shows the minimum bending radius when using nylon or urethane tubes.
3. Do not use extremely soft tubes, which need very little force to remove.
4. Be sure to turn off the air supply before connecting/disconnecting tubes.
Also, be sure to check that all the air has been exhausted from the tubing before starting.

mm [in.]

Tube size	Minimum bending radius	
	Nylon tube	Urethane tube
$\phi 3$ [0.118]	—	7 [0.276]
$\phi 4$ [0.157]	20 [0.787]	10 [0.394]
$\phi 6$ [0.236]	30 [1.181]	15 [0.591]
$\phi 8$ [0.315]	50 [1.969]	20 [0.787]
$\phi 10$ [0.394]	80 [3.150]	27 [1.063]
$\phi 12$ [0.472]	150 [5.906]	35 [1.378]

● Speed adjustment for drive devices

- ① To increase speed

The speed of the drive device increases when the speed controller dial indicator is rotated counterclockwise from "0" (needle fully closed).

When you reach the desired speed, be sure to lock it (press the adjustment knob) so that the set speed does not deviate.

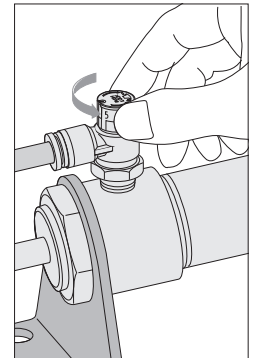

- ② To decrease speed

If the speed of the drive device is too fast, release the lock and rotate the adjustment knob clockwise to reduce the speed of the drive device.

When you reach the desired speed, be sure to lock it (press the adjustment knob) so that the set speed does not deviate.

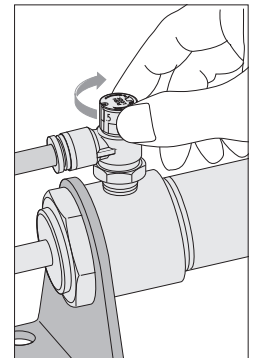

Dimensions (Elbow) (mm [in.])

SCD □



Meter-out control



Meter-in control

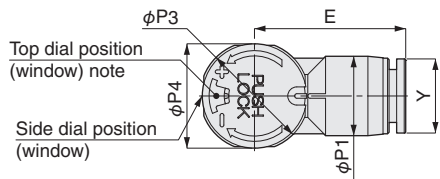

Release ring dimensions

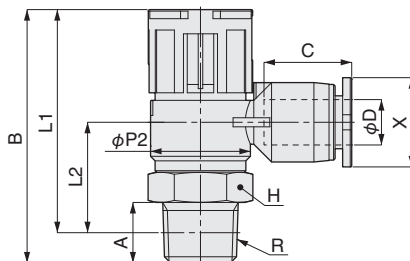
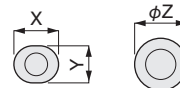

Tapered threads for pipes

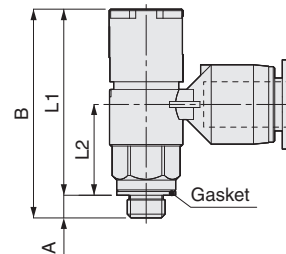

Metric threads (mm [in.])

Note: Thread sizes M3 and M5 (metric threads) do not have a dial on top.

Standard model	Tube diameter φD	R	A	B		L1		L2	φP1	φP2	φP3	φP4	Tube end C	E	Width across flats H	Release ring			Mass (g [oz])
				Unlock	Lock	Unlock	Lock									Exterior diameter φZ	X	Y	
SCD(C)3-M3-□	3 [0.118]	M3×0.5	2.5 [0.098]	27.6	26.7	25.1 [0.988]	24.2 [0.953]	12.5 [0.492]	8 [0.315]	9.7 [0.382]	10.4 [0.409]	9.8 [0.386]	11 [0.433]	17.3 [0.681]	8 [0.315]	-	9.8 [0.386]	7.8 [0.307]	6.5 [0.23]
SCD(C)3-M5-□		M5×0.8	3 [0.118]	1.087	1.051	24.6 [0.969]	23.7 [0.933]	12 [0.472]											
SCD(C)4-M3-□	4 [0.157]	M3×0.5	2.5 [0.098]	27.6	26.7	25.1 [0.988]	24.2 [0.953]	12.5 [0.492]	8 [0.315]	9.7 [0.382]	10.4 [0.409]	9.8 [0.386]	11 [0.433]	17.3 [0.681]	8 [0.315]	-	9.8 [0.386]	7.8 [0.307]	6.6 [0.23]
SCD(C)4-M5-□		M5×0.8	3 [0.118]	1.087	1.051	24.6 [0.969]	23.7 [0.933]	12 [0.472]											
SCD(C)4-01-□		R1/8	8 [0.315]	33.5 [1.319]	32.5 [1.280]	29.5 [1.161]	28.5 [1.122]	14.6 [0.575]	10.5 [0.413]	13.2 [0.520]	14.4 [0.567]	13.8 [0.543]	11 [0.433]	17.6 [0.693]	12 [0.472]	-	9.8 [0.386]	7.8 [0.307]	14 [0.49]
SCD(C)6-M5-□		M5×0.8	3 [0.118]	1.087	1.051	24.6 [0.969]	23.7 [0.933]	12 [0.472]											
SCD(C)6-01-□	6 [0.236]	R1/8	8 [0.315]	33.5 [1.319]	32.5 [1.280]	29.5 [1.161]	28.5 [1.122]	14.6 [0.575]	10.5 [0.413]	13.2 [0.520]	14.4 [0.567]	13.8 [0.543]	11.6 [0.457]	20 [0.787]	12 [0.472]	-	11.8 [0.465]	9.8 [0.386]	14 [0.49]
SCD(C)6-02-□		R1/4	11 [0.433]	39.8 [1.567]	38.8 [1.528]	33.8 [1.331]	32.8 [1.291]	17.5 [0.689]											
SCD(C)6-03-□		R3/8	12 [0.472]	48.8 [1.921]	47.6 [1.874]	42.5 [1.673]	41.3 [1.626]	25.2 [0.992]											
SCD(C)8-01-□	8 [0.315]	R1/8	8 [0.315]	33.5 [1.319]	32.5 [1.280]	29.5 [1.161]	28.5 [1.122]	16.8 [0.661]	14.5 [0.571]	13.2 [0.520]	14.4 [0.567]	13.8 [0.543]	18.1 [0.713]	30.5 [1.201]	12 [0.472]	-	-	-	17 [0.60]
SCD(C)8-02-□		R1/4	11 [0.433]	39.8 [1.567]	38.8 [1.528]	33.8 [1.331]	32.8 [1.291]	17.5 [0.689]											
SCD(C)8-03-□		R3/8	12 [0.472]	48.8 [1.921]	47.6 [1.874]	42.5 [1.673]	41.3 [1.626]	25.2 [0.992]											
SCD(C)8-04-□		R1/2	15 [0.591]	54 [2.126]	52.8 [2.079]	45.8 [1.803]	44.6 [1.756]	26.9 [1.059]											
SCD(C)10-02-□	10 [0.394]	R1/4	11 [0.433]	39.8 [1.567]	38.8 [1.528]	33.8 [1.331]	32.8 [1.291]	17.5 [0.689]	17.5 [0.689]	16.8 [0.661]	14.4 [0.567]	13.8 [0.543]	20.2 [0.795]	32.1 [1.264]	17 [0.669]	-	-	-	31 [1.09]
SCD(C)10-03-□		R3/8	12 [0.472]	48.8 [1.921]	47.6 [1.874]	42.5 [1.673]	41.3 [1.626]	25.2 [0.992]											
SCD(C)10-04-□		R1/2	15 [0.591]	54 [2.126]	52.8 [2.079]	45.8 [1.803]	44.6 [1.756]	26.9 [1.059]											
SCD(C)12-03-□	12 [0.472]	R3/8	12 [0.472]	48.8 [1.921]	47.6 [1.874]	42.5 [1.673]	41.3 [1.626]	25.2 [0.992]	21 [0.827]	21 [0.827]	19.6 [0.772]	-	23.4 [0.921]	37.2 [1.465]	19 [0.748]	-	-	-	58 [2.05]
SCD(C)12-04-□		R1/2	15 [0.591]	54 [2.126]	52.8 [2.079]	45.8 [1.803]	44.6 [1.756]	26.9 [1.059]											

Dimensions (Union straight) (mm [in.])

SSUD

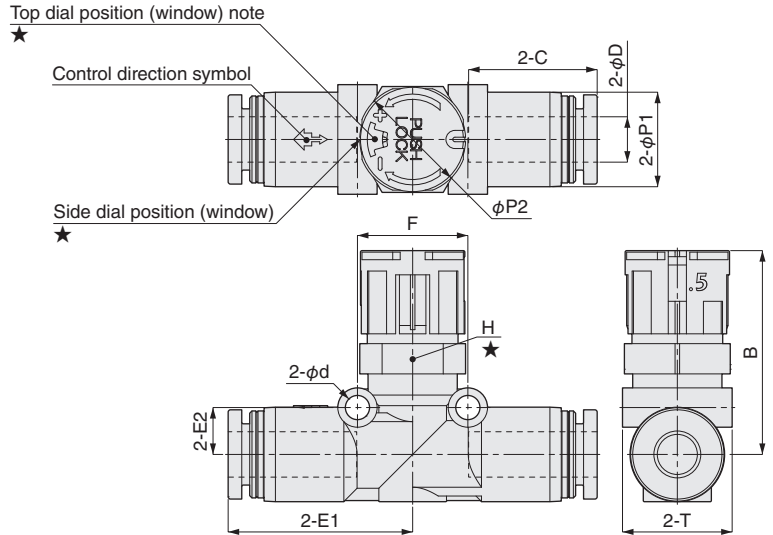

Note: Tube size 4 (φ4 [0.157]) does not have a dial on top.

Standard model	Tube diameter φD	B		φP1	φP2	Tube end C	E1	E2	Width across flats H	φd	F	T	Mass (g [oz])
		Unlock	Lock										
SSUD(C)4	4 [0.157]	20 [0.787]	19.1 [0.752]	10 [0.394]	10.4 [0.409]	14.9 [0.587]	21 [0.827]	5.3 [0.209]	10 [0.394]	3.2 [0.126]	12.7 [0.500]	10.5 [0.413]	8 [0.28]
SSUD(C)6	6 [0.236]	27 [1.063]	26 [1.024]	12.5 [0.492]	14.4 [0.567]	17 [0.669]	24.4 [0.961]	6.2 [0.244]	14 [0.551]	3.2 [0.126]	14.8 [0.583]	14.5 [0.571]	14 [0.49]
SSUD(C)8	8 [0.315]	28.5 [1.122]	27.5 [1.083]	14.8 [0.583]	14.4 [0.567]	18.1 [0.713]	28 [1.102]	8.4 [0.331]	14 [0.551]	3.2 [0.126]	18.2 [0.717]	15.4 [0.606]	20 [0.71]
SSUD(C)10	10 [0.394]	32 [1.260]	30.8 [1.213]	18.2 [0.717]	19.6 [0.772]	20.2 [0.795]	31.8 [1.252]	10.3 [0.406]	19 [0.748]	4.2 [0.165]	22.2 [0.874]	19.7 [0.776]	37 [1.31]
SSUD(C)12	12 [0.472]	35.2 [1.386]	34 [1.339]	21.2 [0.835]	19.6 [0.772]	23.4 [0.921]	36.9 [1.453]	12.2 [0.480]	21 [0.827]	4.2 [0.165]	25.7 [1.012]	22.7 [0.894]	54 [1.90]

★ For union straight dial models, you can turn and adjust the orientation of the dial indicator 360° by using a wrench on the flat sides below the dial.

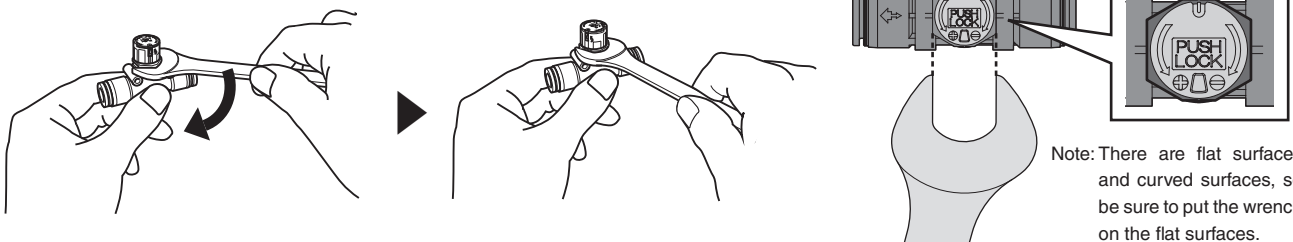

Flow characteristics (Elbow)

SCDC3-M3 □

Controlled flow

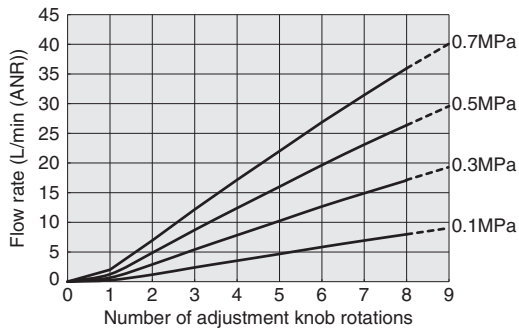

SCD3-M3 □

Controlled flow

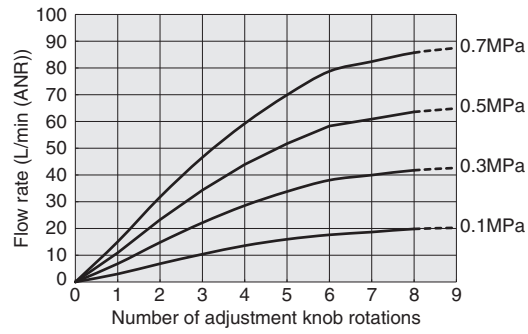

SCD(C)3-M3 □

Free flow

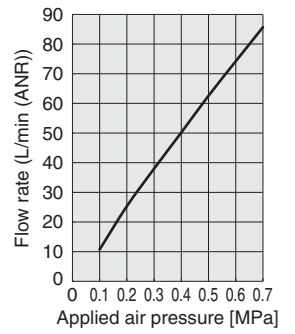

SCDC3-M5 □

Controlled flow

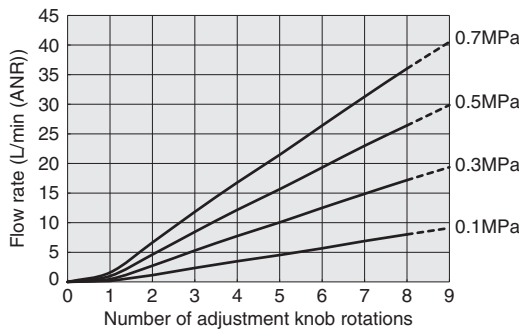

SCD3-M5 □

Controlled flow

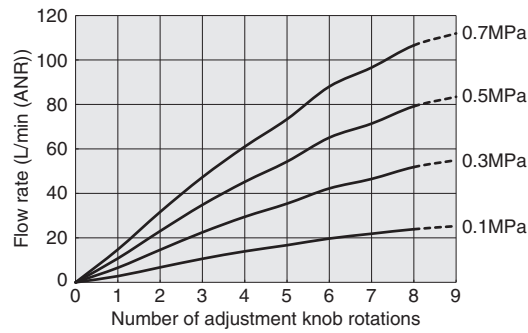

SCD(C)3-M5 □

Free flow

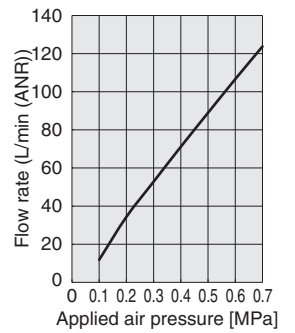

SCDC4-M3 □

Controlled flow

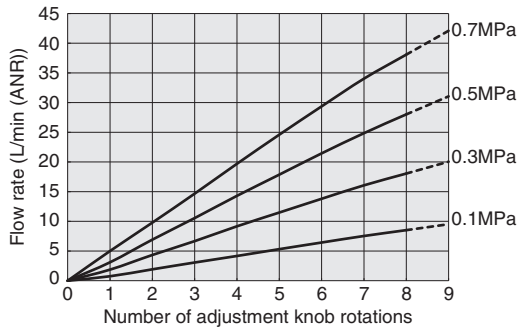

SCD4-M3 □

Controlled flow

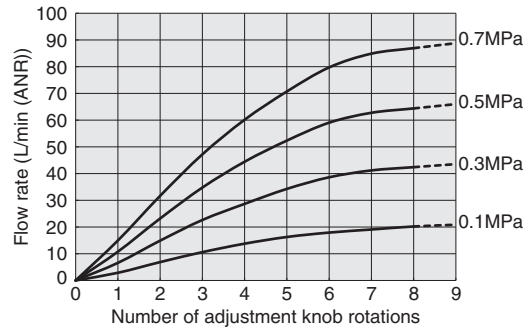

SCD(C)4-M3 □

Free flow

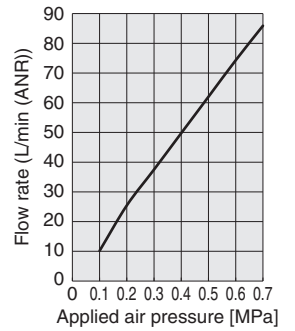

SCDC4-M5 □

Controlled flow

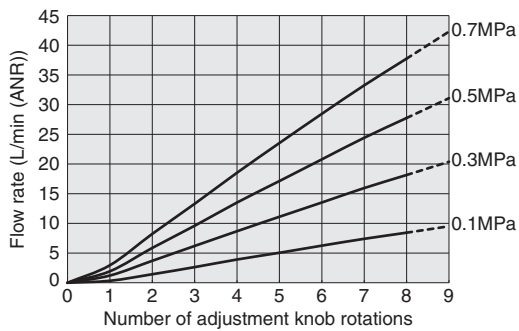

SCD4-M5 □

Controlled flow

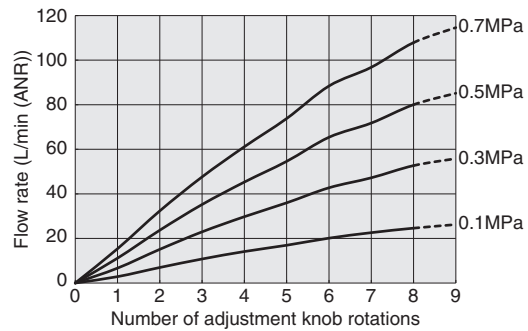

SCD(C)4-M5 □

Free flow

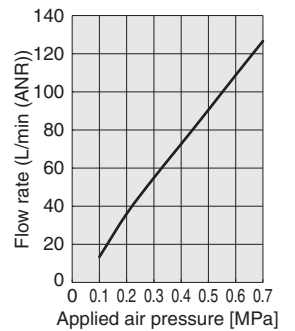

Flow characteristics (Elbow)

SCDC4-01 □

Controlled flow

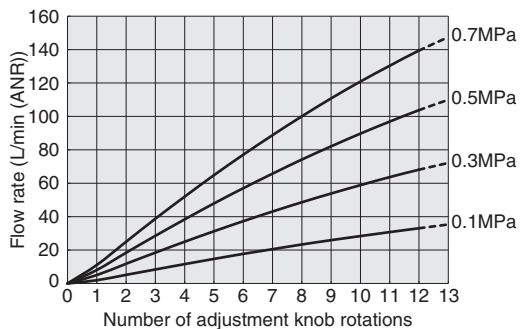

SCD4-01 □

Controlled flow

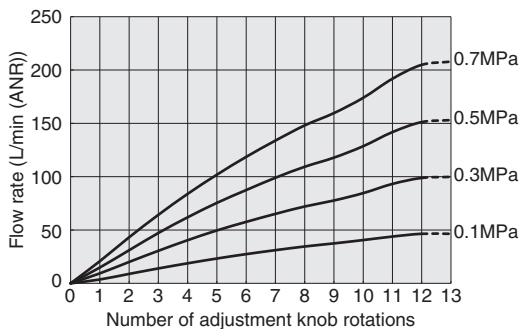

SCD(C)4-01 □

Free flow

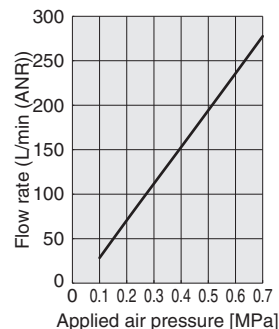

SCDC6-M5 □

Controlled flow

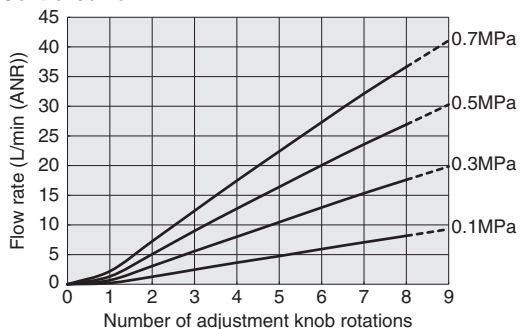

SCD6-M5 □

Controlled flow

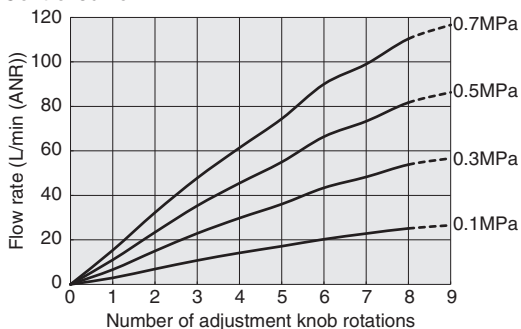

SCD(C)6-M5 □

Free flow

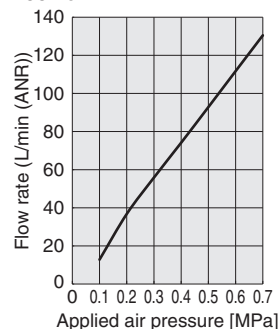

SCDC6-01 □

Controlled flow

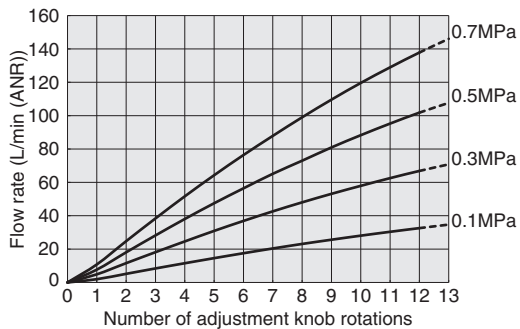

SCD6-01 □

Controlled flow

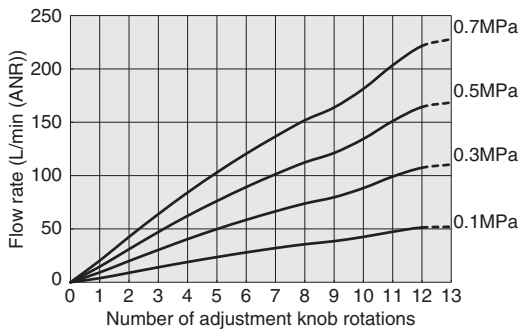

SCD(C)6-01 □

Free flow

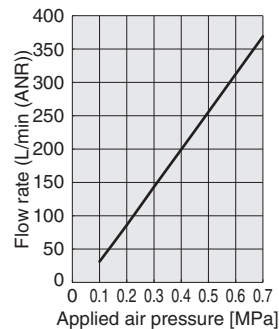

SCDC6-02 □

Controlled flow

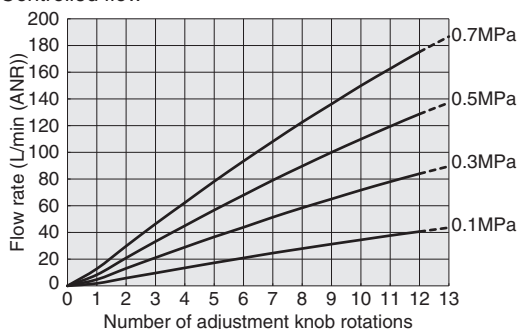

SCD6-02 □

Controlled flow

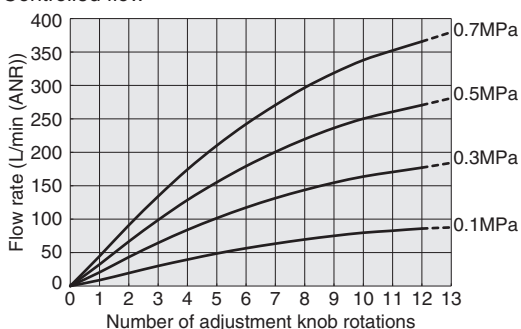

SCD(C)6-02 □

Free flow

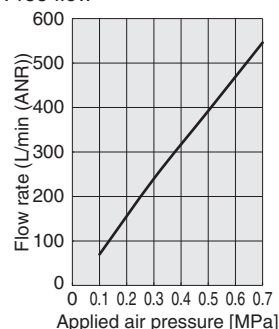

Note: The final speed should be checked occasionally, since it will depend on the individual difference of the product, individual difference of the actuator, and operating conditions such as temperature.

Flow characteristics (Elbow)

SCDC6-03

Controlled flow

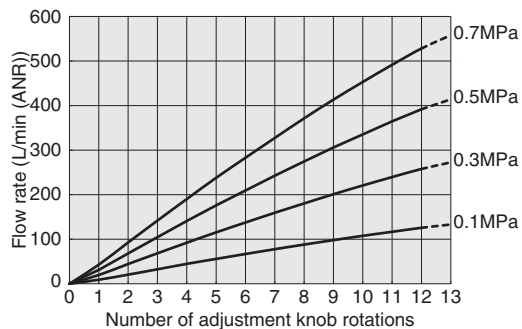

SCD6-03

Controlled flow

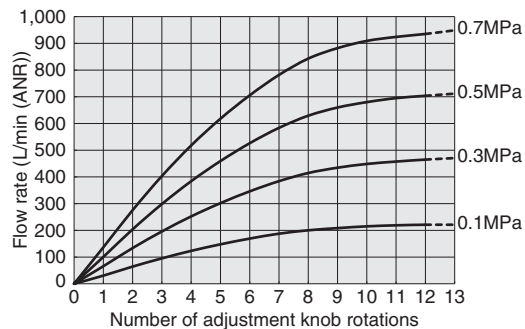

SCD(C)6-03

Free flow

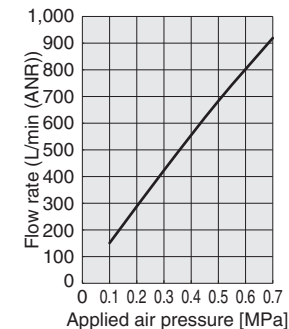

SCDC8-01

Controlled flow

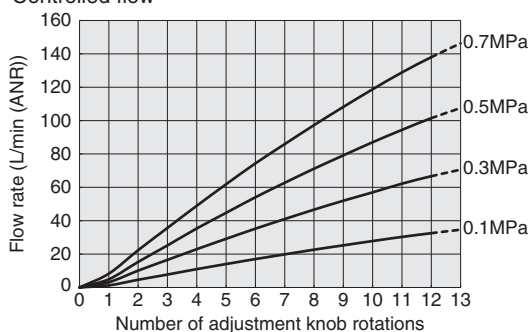

SCD8-01

Controlled flow

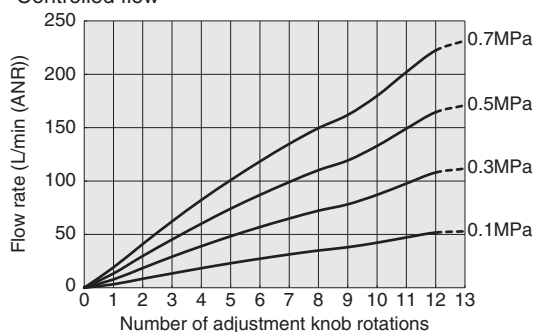

SCD(C)8-01

Free flow

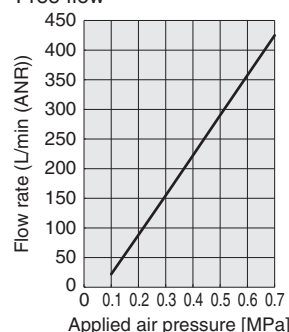

SCDC8-02

Controlled flow

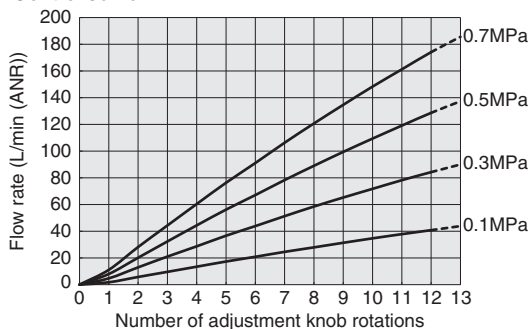

SCD8-02

Controlled flow

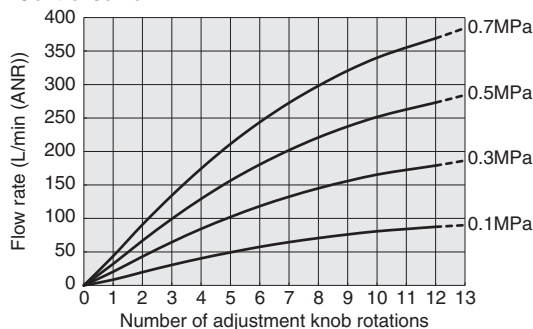

SCD(C)8-02

Free flow

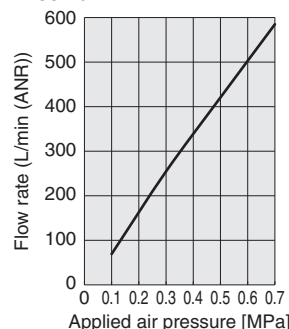

SCDC8-03

Controlled flow

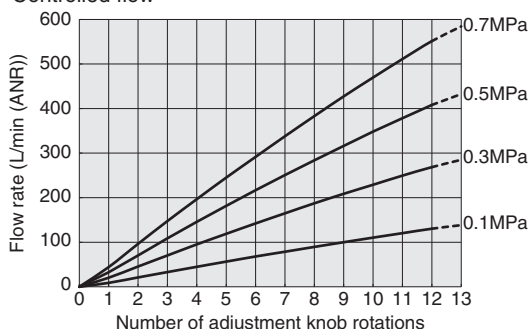

SCD8-03

Controlled flow

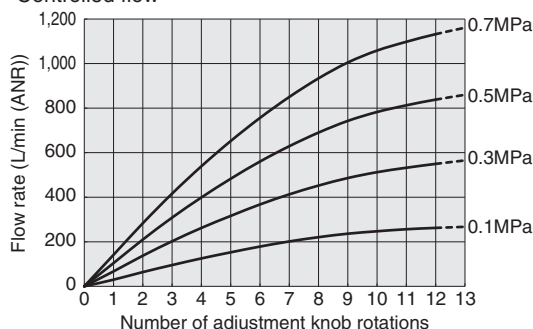

SCD(C)8-03

Free flow

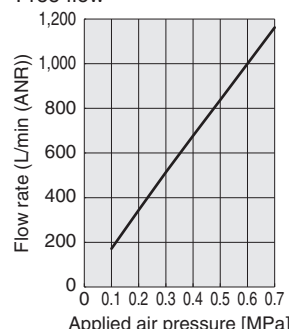

Flow characteristics (Elbow)

SCDC8-04

Controlled flow

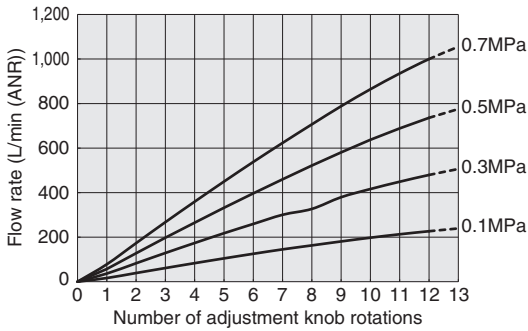

SCD8-04

Controlled flow

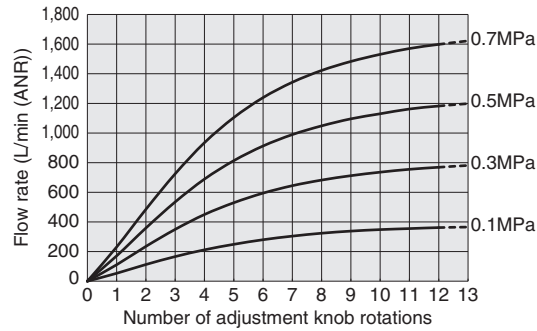

SCD(C)8-04

Free flow

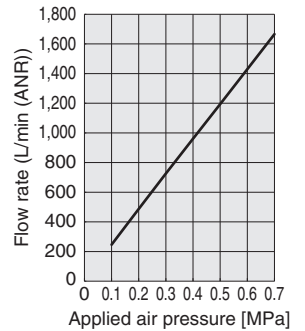

SCDC10-02

Controlled flow

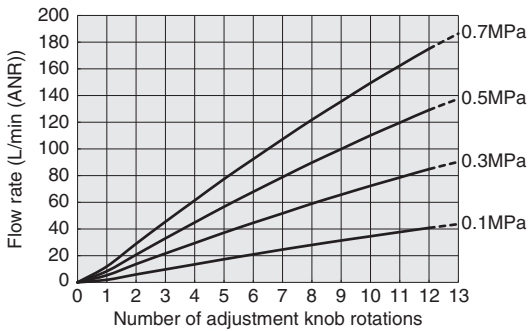

SCD10-02

Controlled flow

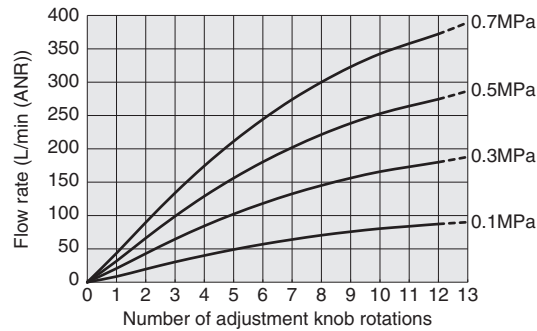

SCD(C)10-02

Free flow

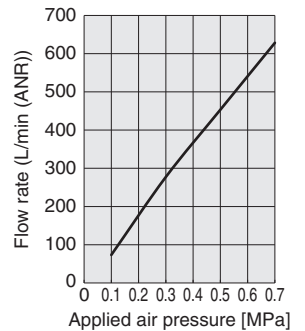

SCDC10-03

Controlled flow

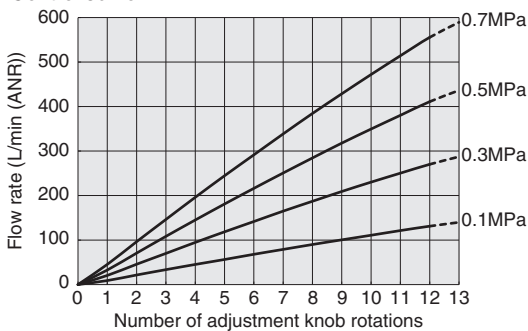

SCD10-03

Controlled flow

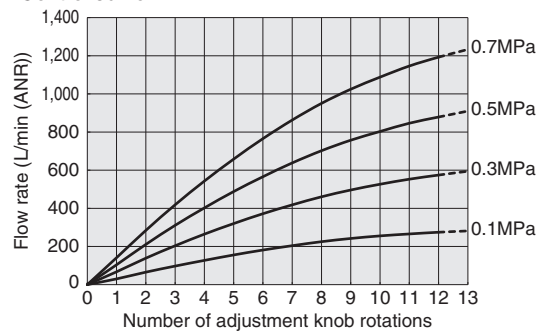

SCD(C)10-03

Free flow

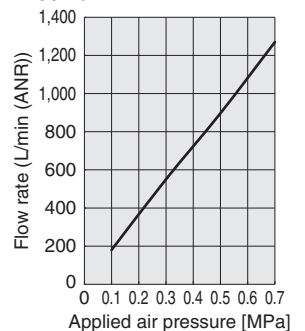

SCDC10-04

Controlled flow

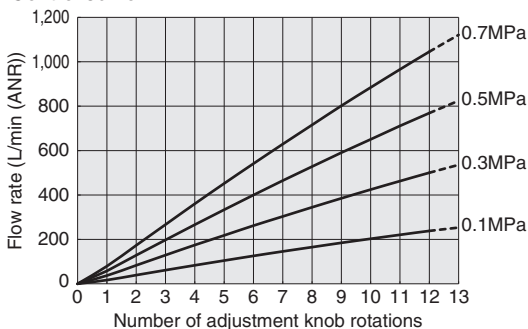

SCD10-04

Controlled flow

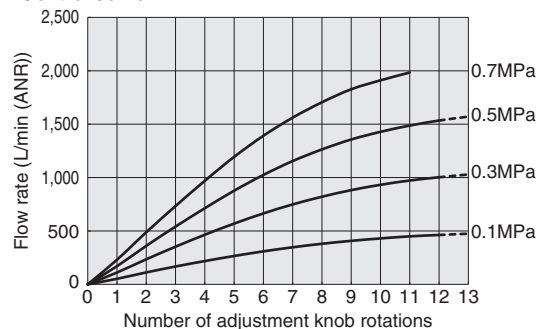

SCD(C)10-04

Free flow

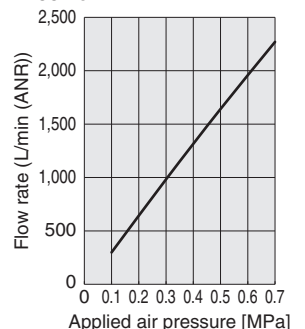

Note: The final speed should be checked occasionally, since it will depend on the individual difference of the product, individual difference of the actuator, and operating conditions such as temperature.

Flow characteristics (Elbow)

SCDC12-03
Controlled flow

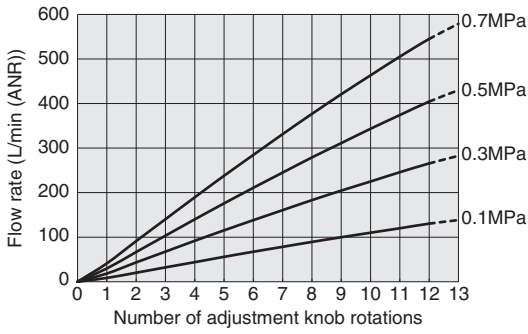

SCD12-03
Controlled flow

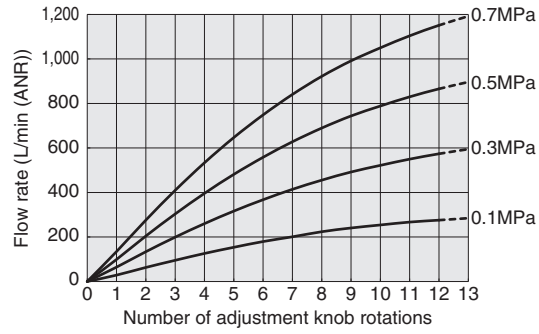

SCD(C)12-03
Free flow

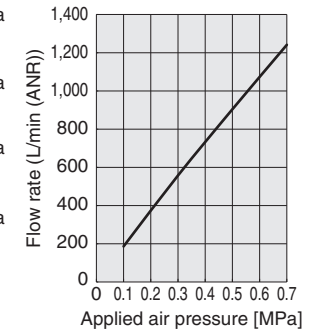

SCDC12-04
Controlled flow

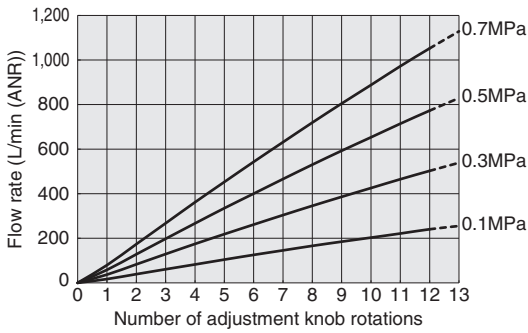

SCD12-04
Controlled flow

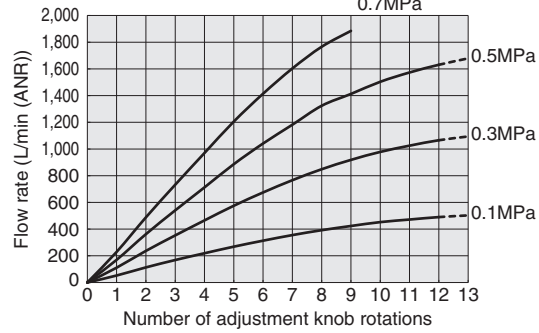

SCD(C)12-04
Free flow

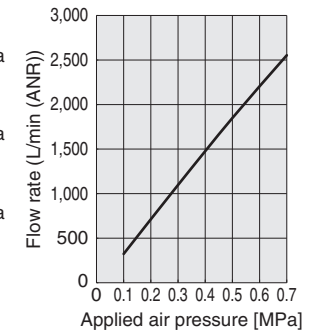

Flow characteristics (Union straight)

SSUDC4

Controlled flow

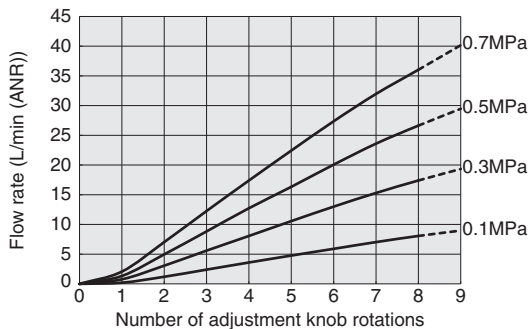

SSUD4

Controlled flow

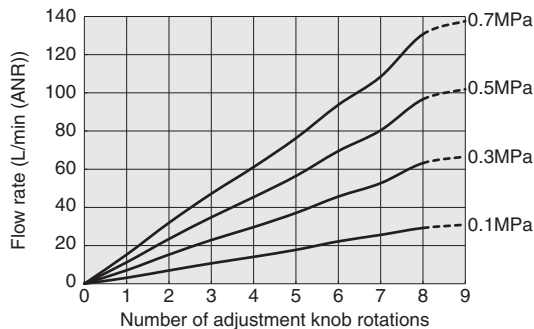

SSUD(C)4

Free flow

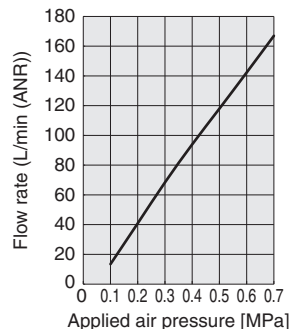

SSUDC6

Controlled flow

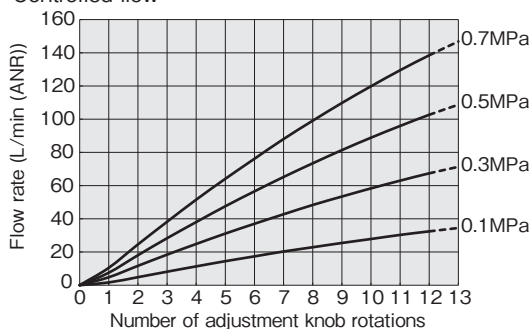

SSUD6

Controlled flow

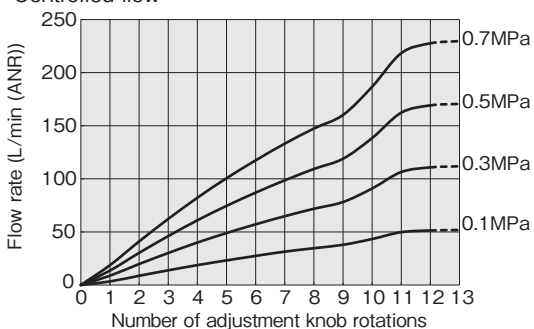

SSUD(C)6

Free flow

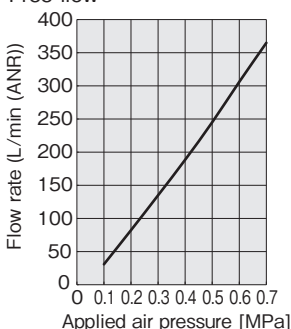

SSUDC8

Controlled flow

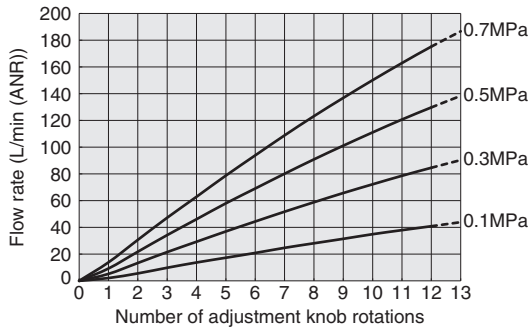

SSUD8

Controlled flow

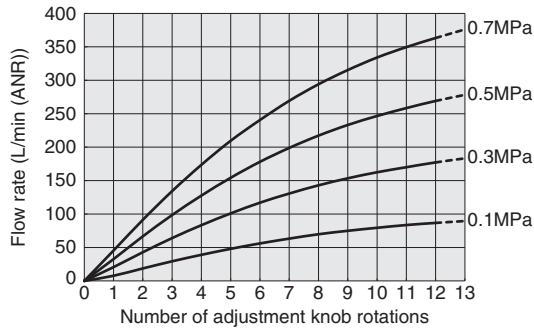

SSUD(C)8

Free flow

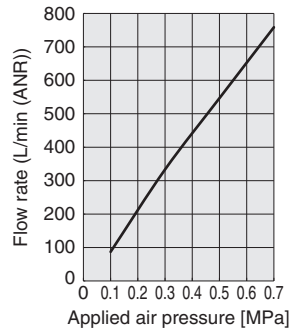

SSUDC10

Controlled flow

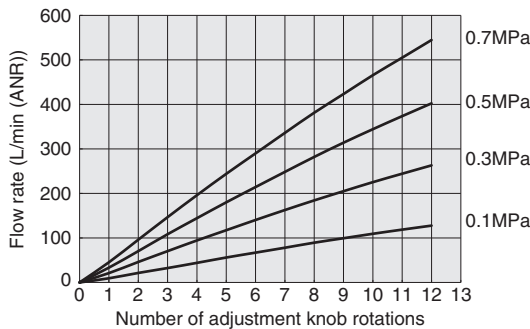

SSUD10

Controlled flow

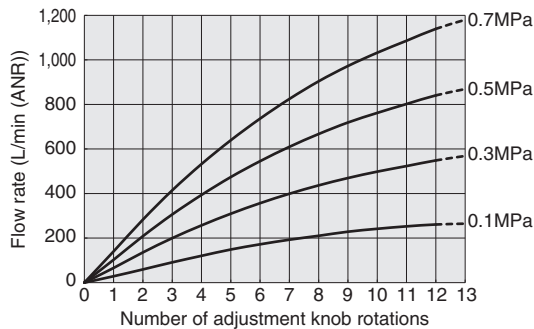

SSUD(C)10

Free flow

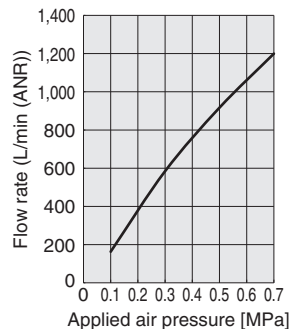

Note: The final speed should be checked occasionally, since it will depend on the individual difference of the product, individual difference of the actuator, and operating conditions such as temperature.

Flow characteristics (Union straight)

SSUDC12

Controlled flow

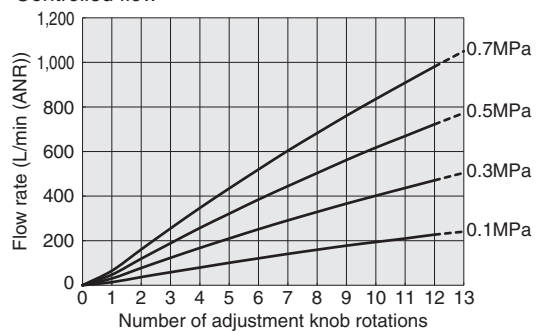

SSUD12

Controlled flow

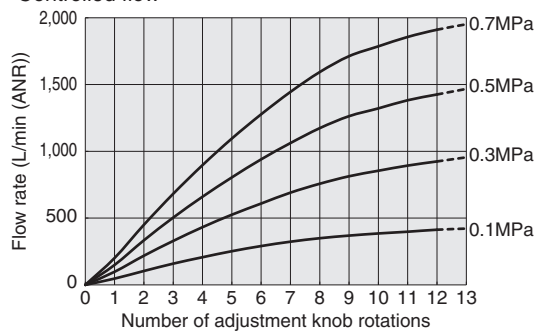

SSUD(C)12

Free flow

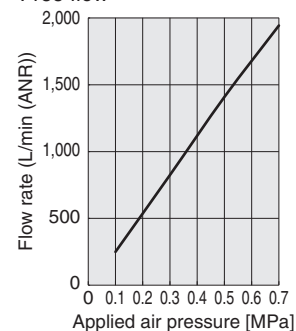

Note: The final speed should be checked occasionally, since it will depend on the individual difference of the product, individual difference of the actuator, and operating conditions such as temperature.

Limited Warranty

KOGANEI CORP. warrants its products to be free from defects in material and workmanship subject to the following provisions.

Warranty Period The warranty period is 180 days from the date of delivery.

Koganei Responsibility If a defect in material or workmanship is found during the warranty period, KOGANEI CORP. will replace any part proved defective under normal use free of charge and will provide the service necessary to replace such a part.

Limitations

- This warranty is in lieu of all other warranties, expressed or implied, and is limited to the original cost of the product and shall not include any transportation fee, the cost of installation or any liability for direct, indirect or consequential damage or delay resulting from the defects.

- KOGANEI CORP. shall in no way be liable or responsible for injuries or damage to persons or property arising out of the use or operation of the manufacturer's product.

- This warranty shall be void if the engineered safety devices are removed, made inoperative or not periodically checked for proper functioning.

- Any operation beyond the rated capacity, any improper use or application, or any improper installation of the product, or any substitution upon it with parts not furnished or approved by KOGANEI CORP., shall void this warranty.

- This warranty covers only such items supplied by KOGANEI CORP. The products of other manufacturers are covered only by such warranties made by those original manufacturers, even though such items may have been included as the components.

The specifications are subject to change without notice.

URL: <http://www.koganeiusa.com>

E-mail: sales@koganeiusa.com



KOGANEI CORPORATION

OVERSEAS DEPARTMENT

3-11-28, Midori-cho, Koganei City, Tokyo 184-8533, Japan
Tel: 81-42-383-7271 Fax: 81-42-383-7276

KOGANEI INTERNATIONAL AMERICA, INC.

48860 Milmont Drive, Suite 108C, Fremont, California 94538
Tel: 1-510-744-1626 Fax: 1-510-744-1676

SHANGHAI KOGANEI INTERNATIONAL TRADING CORPORATION

Room 2606-2607, Tongda Venture Building No.1, Lane 600, Tianshan Road,
Shanghai, 200051, China
Tel: 86-21-6145-7313 Fax: 86-21-6145-7323

TAIWAN KOGANEI TRADING CO., LTD.

Rm. 2, 13F., No88, Sec. 2, Zhongxiao E. Rd., Zhongzheng Dist., Taipei City 100,
Taiwan (ROC)
Tel: 886-2-2393-2717 Fax: 886-2-2393-2719

KOGANEI KOREA CO., LTD.

6F-601, Tower Bldg., 1005, Yeongdeong-dong, Giheung-gu, Yongin-si, Gyeonggi-do,
446-908, Korea
Tel: 82-31-246-0414 Fax: 82-31-246-0415

KOGANEI (THAILAND) CO., LTD.

3300/90, Tower B, Elephant Tower, 16th Fl., Phaholyothin Road, Chomphon,
Chatuchak, Bangkok 10900, Thailand
Tel: 66-2-937-4250 Fax: 66-2-937-4254

KOGANEI AUTOMATION (MALAYSIA) SDN.BHD.

Suite 29-2, Level 29, Menara 1MK, No.1, Jalan Kiara, Mont Kiara
50480, Kuala Lumpur, Malaysia
Tel: 60-12-537-7086

KOGANEI ASIA PTE. LTD.

69 Ubi Road 1, #05-18 Oxley Bizhub, Singapore 408731
Tel: 65-6293-4512 Fax: 65-6293-4513